

DECEMBER 1979

# HEWLETT-PACKARD JOURNAL



12050A FIBER OPTIC HP-IB LINK  
HEWLETT • PACKARD

LINK  
INTEGRITY



ATN  
MESSAGE IN PROCESS



OPTIC  
REC

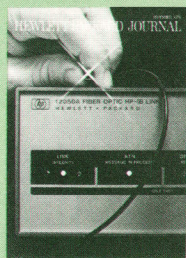


SELF TEST

## Contents:

- 3 High-Speed Fiber Optic Link Provides Reliable Real-Time HP-IB Extension**, by Robert B. Grady *Distances up to 100 metres are no longer a barrier to high-speed, noise-immune communications between HP-IB instruments and controllers.*
- 5 A Ready-to-Use Fiber Optic Link for Data Communications**, by Delon C. Hanson *The fiber optic part of the new HP-IB extender is a standard HP product.*
- 10 A Picoammeter with Built-in, Synchronized Voltage Sources**, by Hitoshi Noguchi *It measures very low currents and capacitances, as functions of voltage if desired, for evaluating components, materials, and semiconductor devices.*
- 15 1979 Index**
- 20 Personal Calculator Has Key to Solve Any Equation  $f(x) = 0$** , by William M. Kahan *If you can write a program for your equation, this handheld calculator will find the root (usually).*
- 27 Viewpoints—Don Loughry on ANSI/IEEE Standard 488 and the HP Interface Bus** *A brief look at the past, present, and future of the HP-IB and how it relates to IEEE 488.*
- 29 Four-Color Plotters Enhanced for Unattended Operation**, by Majid Azmoon, Randy A. Coverstone, and Richard M. Kemplin *Now three HP plotters can produce plot after plot automatically under computer control.*

## In this Issue:



December is our annual index issue. The 1979 index is on the center four pages of this issue, so you can remove it and file it elsewhere without affecting any of the articles.

Our cover subject is the new 12050A Fiber Optic HP-IB Link. The HP-IB is Hewlett-Packard's version of an industry standard method for connecting instruments and computers to form a system. If ordinary cables are used for the connections, their lengths can't add up to more than 20 metres, according to the standard. In our August 1979 issue we featured a product that uses telephone lines to overcome this limitation and send HP-IB information around the world if need be. The new fiber optic link doesn't send it quite that far—100 metres is the maximum distance now—but it's much faster than telephone transmission.

Fiber optic cables, the link part of the 12050A, are those thin flexible strands that take in light at one end, guide it this way and that, and finally spit it out the other end, having lost very little of it in the process. You transmit information over them by varying the intensity of the light source. Besides speed of transmission, they provide electrical isolation and noise immunity. The cables used by the 12050A are another HP product.

The present form of the HP-IB is now about five years old and its use is still spreading. On page 27, Don Loughry, who helped bring it into being, shares some of his thoughts on its past, present, and future.

Engineers and scientists often have to solve (find the roots of) equations of a certain type. The problem can be stated simply as follows: Given a formula that asks for a number and returns another number, what number do you put in to make zero come out? It's not a simple problem. It often requires a trial-and-error solution: guess at the root, compute the result, and if it isn't zero, adjust your guess and try again. Computers are good at this, but it takes an expert to use one properly. There are many pitfalls. Now you can have the computer and the expert in the palm of your hand, in the form of the **SOLVE** key on the HP-34C Calculator (see page 20). You still have to know what you're doing, but **SOLVE** automatically avoids many of the pitfalls.

Picoammeters measure very tiny currents, like those that run over the surfaces of printed circuit boards or leak through transistor switches that are turned off. Because current is a result of an applied voltage, a voltage source is often needed when such currents are being measured. Model 4140A Picoammeter (page 10) is a very stable instrument that has built-in voltage sources for generating bias, step, and ramp voltages. It measures capacitances, too, and is HP-IB compatible, of course.

And on page 29 is an article about a new mechanism that automatically changes the paper on HP four-color plotters so the operator doesn't have to hang around all the time.

-R. P. Dolan

# High-Speed Fiber Optic Link Provides Reliable Real-Time HP-IB Extension

*Remote instruments and peripherals can now communicate on the HP Interface Bus with a computer/controller up to 100 metres away. This new fiber optic link is fast and has exceptional immunity to severe industrial environments.*

by Robert B. Grady

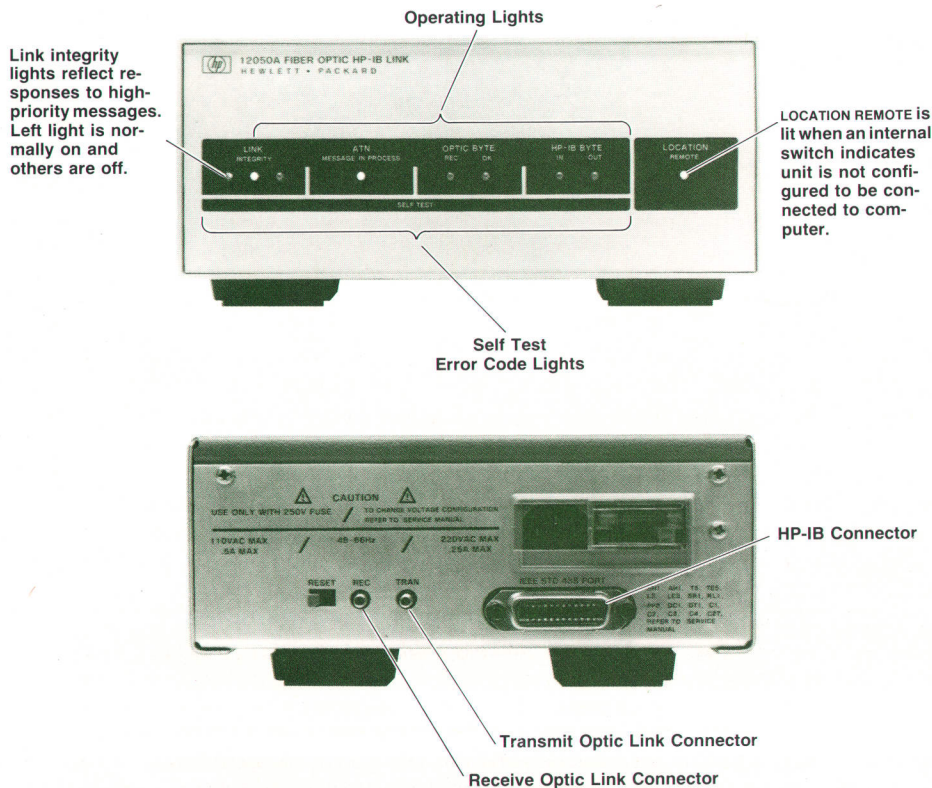
**F**OR MANY YEARS, systems engineers have struggled to simplify and standardize the connection of instruments to computers. The problem has many aspects, including interface circuitry, data formats, protocol functions, timing, and software-related issues. In 1975, IEEE standard 488 was adopted, defining an interface system "optimized as an interdevice interface for system components in relatively close proximity able to communicate over a contiguous party-line bus system."<sup>1</sup> It allows users to connect up to fifteen devices to form a system. This standard has gained wide acceptance; today over 600 devices manufactured by many companies have IEEE 488 compatibility. Hewlett-Packard's version of IEEE 488 is called the HP Interface Bus, or HP-IB.

The proliferation of devices compatible with it makes the HP-IB attractive to a broad user base, which brings with it new problems and environments that challenge the IEEE

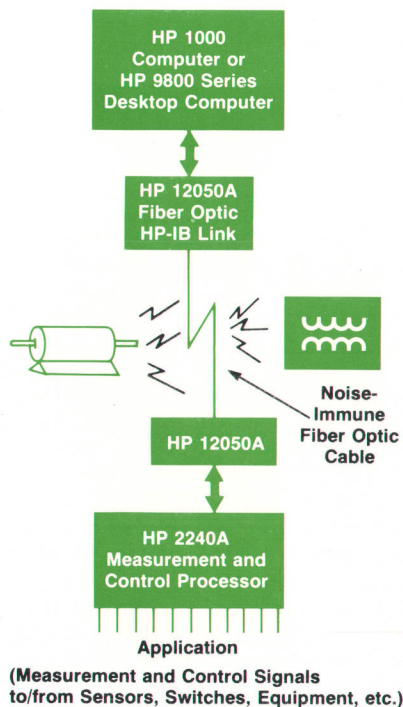
standard specification. One trend is toward smarter devices capable of functions previously found in the domain of the computing controller (control, data processing, storage, and high-speed communications). Another trend is a growing need to distribute these devices to remote areas around a laboratory or industrial process, separated by distances that exceed the cable length limitations of the IEEE standard.

## A Fresh Look at the Interface

The 12050A Fiber Optic HP-IB link (one unit shown in Fig. 1) removes the necessity of locating HP-IB instruments in "relatively close proximity" to a computer, while maintaining the real-time characteristics necessary to many applications. Fiber optics was selected as the transmission medium partly because the areas where the HP-IB is increasingly used present harsh electromagnetic noise environments. Since fiber optic transmission is via light, it is



**Fig. 1.** Model 12050A Fiber Optic HP-IB Link can transfer data over the HP Interface Bus (compatible with ANSI/IEEE 488-1978) at 20 kilobytes per second. It performs error detection and automatic retransmission, and has powerful internal and link testing capabilities.



**Fig. 2.** In a typical application, a 12050A connects a computer to a group of HP-IB instruments up to 100 metres away. The fiber optic cable is immune to electrical noise and lightning, provides electrical isolation for rejection of common mode signals such as ground potential differences, is safe in explosive environments, and can reduce installation costs by eliminating the need for special protective equipment or shielding.

completely immune to this interference, which plays havoc with normal electrical signals. Fiber optic transmission also provides isolation to prevent common-mode voltage problems, and is safe in explosive environments.

The 12050A emphasizes real-time operation by continuously transmitting data at over 20 kilobytes per second and by asserting each service request (SRQ) at the computer end of the link within 100 microseconds of its occurrence at the remote end. Serial communications are performed at one megabit per second for data and protocol support, and at ten megabits per second for special messages. These specifications ensure that most HP-IB systems perform just as they do when connected in strictly local configurations.

The 12050A detects any errors in transmission from one end of the link to the other and automatically retransmits the data until it is received correctly. At a continuous rate of 1 Mbit/second, over  $10^9$  bits/hour can be transmitted. Most fiber optic parts have specified reliabilities in the range of 1 error in  $10^9$  transmissions. Thus it is important that the 12050A perform automatic error correction, even though the probability of any errors is very small, since many control applications run twenty-four hours a day.

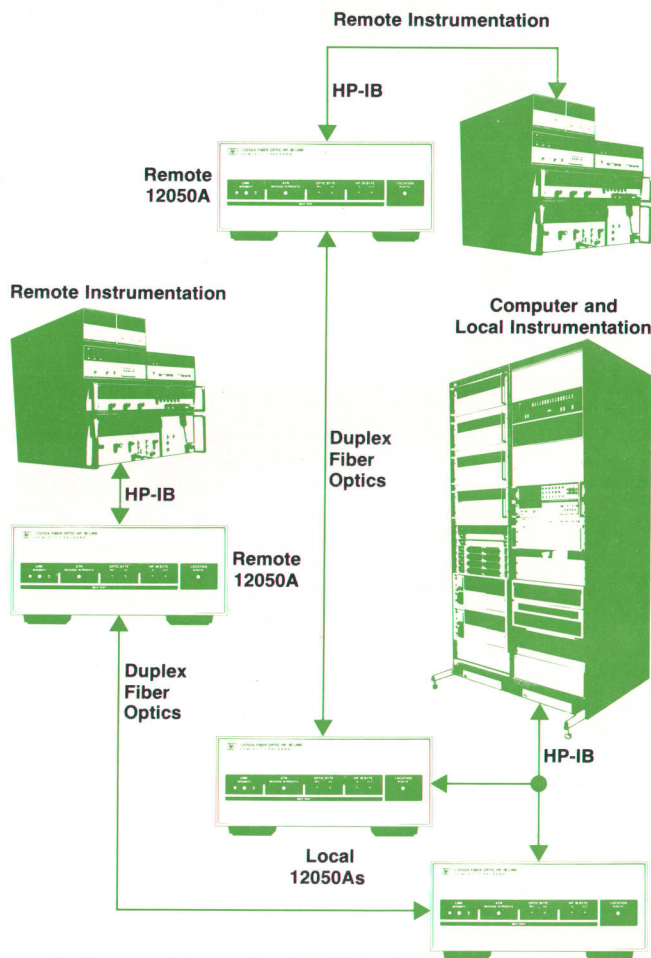
The use of the 12050A Fiber-Optic Link is illustrated in Fig. 2. One unit is connected to the local computer's HP-IB port and another is connected remotely to an instrumentation application. No special programming is necessary to use the 12050A. This is particularly important to many existing applications. Fig. 3 characterizes the typical use

of an instrumentation cluster in a production environment, and demonstrates the ease of duplicating the test set-up while maintaining the advantages of single-computer control.

### Established Technologies Used

A key objective for the development of the 12050A was to use existing hardware and technologies, with an emphasis on HP fiber optic transmitter/receiver pairs and SOS (silicon-on-sapphire) components. These parts provide the high speed and low power consumption that allow the 12050A to achieve real-time operation without overly complex design. In this way, development emphasis could be concentrated on how to make the interface truly behave like a standard HP-IB cable instead of wasting efforts on a broad range of hardware trade-offs.

Centering the design approach around a high-speed SOS microprocessor (see Fig. 4) provides a great deal of flexibility, but at the same time limits the speed of the link. The design center definition of "real-time", however, must recognize the capabilities of today's computers and instrumentation. Few instruments are capable of approaching the one-megabyte-per-second theoretical rate of the HP-IB, and



**Fig. 3.** The fiber optic link makes it easy to duplicate a group of HP-IB instruments at several sites, using a single computer at one site (many production test stations are in this category).

# A Ready-to-Use Fiber-Optic Link for Data Communications

by Delon C. Hanson

During this past year there has been a significant growth in interest in adapting fiber-optic data links to a broad spectrum of applications ranging from local data communications to long-distance telephone communications. This heightened interest results from the advantages that optical fibers have over metallic conductors for transmitting information. The advantages depend on the application but include the following:

- Immunity from electromagnetic interference
- No electromagnetic emission
- Freedom from ground loops
- Smaller cable size and weight
- Higher bandwidth
- Longer link length without repeaters
- Potentially lower cost in volume production.

Interest within Hewlett-Packard in exploring the potential of fiber optics led to establishment of a program several years ago in the HP corporate research laboratories that focused on the requirements for local data communications between computers, terminals, and instruments. Since practical fiber-optic components for these applications did not exist at the time, a system analysis was initiated to specify the functional features of a suitable link and the optimum balance of performance parameters for individual link components.

A basic requirement was that the fiber-optic data link must behave like a TTL gate as far as signal inputs and outputs are concerned. The user would thus not need any special optical expertise. This implies that the transmit/receive modules must accommodate:

- Arbitrary data formats
- Data rates from dc to a specified maximum
- Operation from a single +5V supply
- Monitoring of the link's function.

## Adaptable Coding

The requirement for transmission down to zero hertz with arbitrary data format cannot be implemented in fiber optics as simply as in wire links where the use of opposite polarity pulses can establish a zero average dc level (photons do not have a negative state). Consequently, an internally-generated code, called pulse bipolar with refresh, was developed.

The bipolar code is a translation from a two-level electrical signal to a three-level optical signal (Fig. 1). A mid-level luminance flux is established as the average dc level. For a link specified to transmit data pulses with a minimum width of 100 ns, each positive-going data transition, such as the leading edge of a data pulse, generates a positive 60-ns optical pulse (maximum luminance) and each

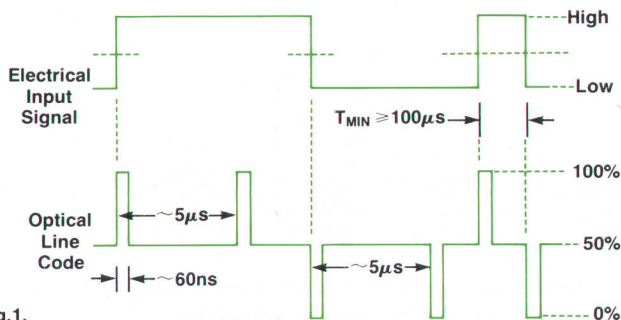


Fig.1.

negative-going data transition, such as a pulse's trailing edge, generates a negative 60-ns pulse (no luminance).

Whenever the time between data transitions exceeds about 5  $\mu$ s, a refresh pulse of the same polarity as the previous pulse is generated and is repeated every 5  $\mu$ s until a data pulse of the opposite polarity occurs. The refresh pulses provide transparent signal continuity independent of the data stream for maintaining ALC (automatic level control) action at the receiver and for use in monitoring the status of the link.

## Transmitter Module

The transmitter uses an LED optical source driven by two current sources: one that is normally on and one that is normally off. The normally-off source is controlled by a gate that is turned on by a positive step in the data stream and off about 60 ns later by an inverted and delayed version of the same step. Similarly, the normally-on current source is turned off by a gate in response to a negative step and on again about 60 ns later in response to an inverted and delayed version of the step.

The refresh circuit consists of a retriggerable monostable multivibrator that has a period of about 5  $\mu$ s. It is triggered on by either data transition. In the absence of a data transition during the refresh period, it resets and the resulting transition is steered to the appropriate optical pulse generating circuits by gates controlled by the data input. The transition also triggers the multivibrator to start a new refresh cycle.

All of the transmitter circuits have been designed into a single integrated circuit housed in a low-profile module that is physically compatible with conventional dual in-line IC packages and that can be mounted directly on printed-circuit boards.

## Receiver Module

The receiver uses a reverse-biased PIN diode as the detector. The diode current is proportional to the received optical power. The peak value of this current can be between 100 nA and 50  $\mu$ A, depending

## Delon C. Hanson



Del Hanson earned a BSEE degree from the University of Wisconsin (1959), an MEE degree from New York University (1961), an MS degree in physics (1966) and PhDEE (1967) from the University of Michigan, and an MBA degree from Golden Gate University (1978). From 1959 to 1964 he was with Bell Telephone Labs and from 1964 to 1967 he was associated with the Electron Physics Lab at the University of Michigan. He joined HP in 1967, initially working on solid-state microwave oscillators. He currently is fiber optic R and D section manager at HP's Optoelectronics Division. Del is an A.Y.S.O. soccer referee and a member-owner of a 5000-acre recreational ranch in northern California where he vacations with his wife and three children (10, 13, 16 years) camping, horse-back riding, hunting, fishing and skiing.

on link length, so ALC is used to force the height of the input amplifier's output pulse to be constant under all conditions. This also improves the signal-to-noise ratio under higher drive conditions. Because of the inclusion of the ALC circuits, no adjustments to the circuit are needed for normal operation.

The ALC voltage also provides a monitor, available at one of the receiver module's output pins, of the presence or absence of an optical input signal.

Comparators with threshold levels at the 25% and 75% points of the bipolar waveform determine whether a data pulse is present and whether it is negative- or positive-going. The positive comparator output sets an RS flip-flop and the negative comparator resets it, regenerating the original two-level data waveform.

The receiver circuits are designed into an integrated circuit that is housed in a module similar to that used for the transmitter.

### Connectors and Cable

Precision single-fiber connectors with a small diameter were developed for inclusion as integral parts of the module and as cable-

even fewer computers begin responding to real-time situations in less than one millisecond. So speeds of 20,000 bytes per second and above are quite adequate for most of today's instrumentation systems, and the ease of developmental changes offered by a microprocessor design was a significant advantage.

### Determining the Critical Timing Paths

There is a complete spectrum of trade-offs between the design that performs the maximum number of logic decisions using a microprocessor and the design that completely eliminates the microprocessor and implements all the logic in hardware alone. The key to a successful microprocessor-based design that maximizes throughput is to implement in hardware those logic decisions that fall into the critical timing paths.

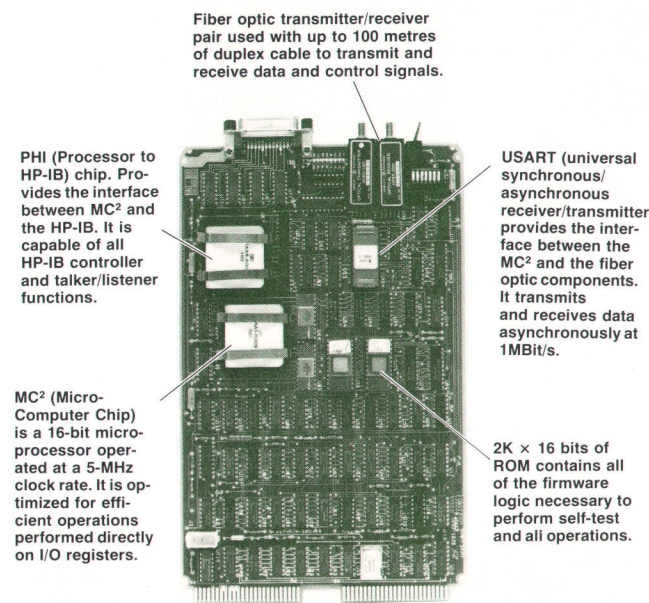


Fig. 4. The fiber optic link has a single printed circuit board with a combination of advanced technologies.

to-cable interconnects. Also developed was a rugged fiber optic cable specifically optimized for local data communications. It has a 100- $\mu\text{m}$ -diameter fused silica core with a glass cladding that is protected by a thin silicone coating between the fiber and a buffer jacket. The buffer jacket is surrounded by strength members and a polyurethane outer jacket to provide a rugged, single-fiber-per-channel cable assembly.

### Acknowledgments

Paul Greene, Tom Hornak, and Bill Brown of HP's Solid-State Research Laboratory were instrumental in the conceptual and prototype phases of this development program. Roland Haitz, George Girot, Steven Garvey, Lee Rhodes, Joe Bagley, and Hans Sorensen of HP's Optoelectronics Division made substantial contributions during final development. Personnel at HP's Santa Clara Division cooperated on the development of and processing for the receiver integrated circuit and many others, unfortunately too many to be mentioned here, made significant contributions to the development program.

A simplified picture of the logic flow controlling the movement of data across the 12050A Fiber Optic Link is illustrated in Fig. 5. There are four key operations:

- Read HP-IB Data
- Format and Transmit the Data
- Receive and Verify the Data
- Write HP-IB Data

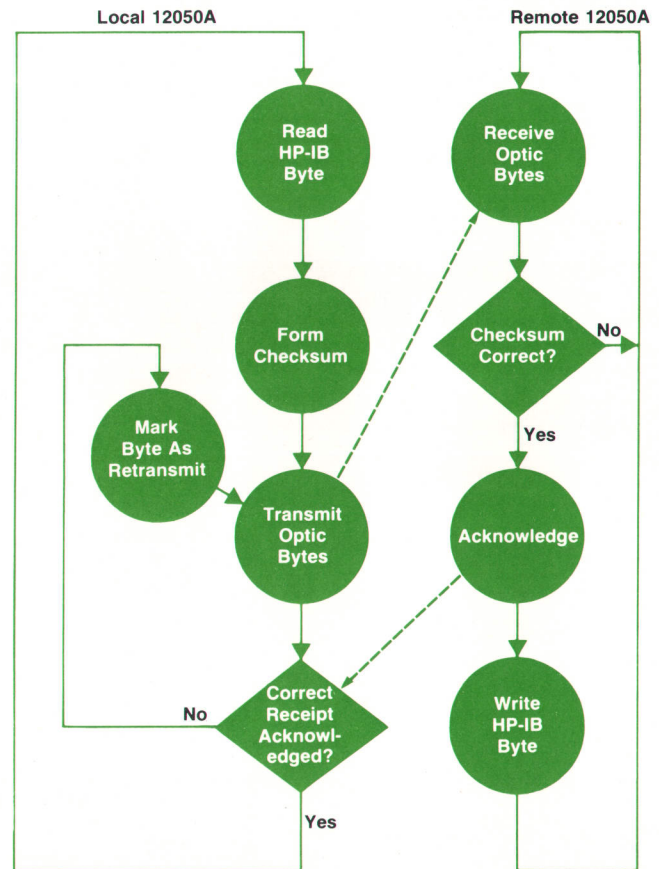


Fig. 5. Simplified flow of HP-IB data in the 12050A. Receipt of each byte is acknowledged by a handshake to the opposite 12050A.

The microprocessor adds a fifth component because the very process of determining which operation to perform takes time. Each of these operations has special hardware logic to minimize the overall time necessary for the entire operation. For example, the receive and verify function is supplemented with two special circuits shown in Fig. 6. The error control circuit verifies correct receipt of the HP-IB byte. Each byte is accompanied by a second byte composed of two bits of control information and six bits of checksum information. This checksum is compared in hardware so that the process of reading the HP-IB byte from the USART (universal synchronous/asynchronous receiver/transmitter) is accompanied by a go/no-go flag. The link command circuits then ensure that acknowledgment of correct receipt of the data is sent in the minimum amount of time to the opposite 12050A. This is done by sending a short burst of pulses at 10 Mbits/second that can be distinguished from normal data by special circuitry. Acknowledgment of HP-IB data on a byte-by-byte basis in this way minimizes the overhead involved in data buffering, and helps to ensure real-time responses to asynchronous messages.

By consciously restricting supplemental circuitry to the critical timing sequences, a secondary design goal was achieved. This was to minimize package size and power consumption. Thus overall cost is minimized through reduced power supply complexity, while reliability is increased. The calculated mean time between failures (MTBF) for the 12050A is greater than 30,000 hours of operation, an important factor in manufacturing applications. At the same time, the emitted radiation of the 12050A is extremely low, making it a good fit for HP-IB systems

concerned with measuring electromagnetic interference (EMI). In actual tests using a 12050A and a 2240A Measurement and Control Processor, the combination of the two instruments was at least 10 dB below the VDE level B requirements for emissions from industrial instrumentation.

### System-Level Capabilities

The fiber optic link, like any other HP-IB device, is assigned its own address and can communicate with the computer. Four powerful system-level requests from the computer to the 12050A are used to determine the general status of the link automatically (Fig. 7). Self-test (S) causes execution of a series of routines contained in the ROM of each individual unit. These routines exercise off-line all of the control logic and circuitry used during normal operation. A failure in any of these tests is indicated by a pattern in the front-panel lights, and indicates that the link cannot operate. This test can also be manually initiated via the reset switch on the 12050A rear panel.

Link test (L) examines the integrity of the complete two-pair link by initiating the transfer of all possible eight-bit ASCII combinations from the local to the remote end. The same patterns are then transferred back from the remote end to the local. During the test all checksum errors are counted, and the local 12050A can be interrogated to determine the results. Extended link test (E) performs the same function as link test 256 times, and the total error counts can be checked as in the link test.

Counting of checksum errors is not restricted to the self-tests. At any convenient time during normal operation,

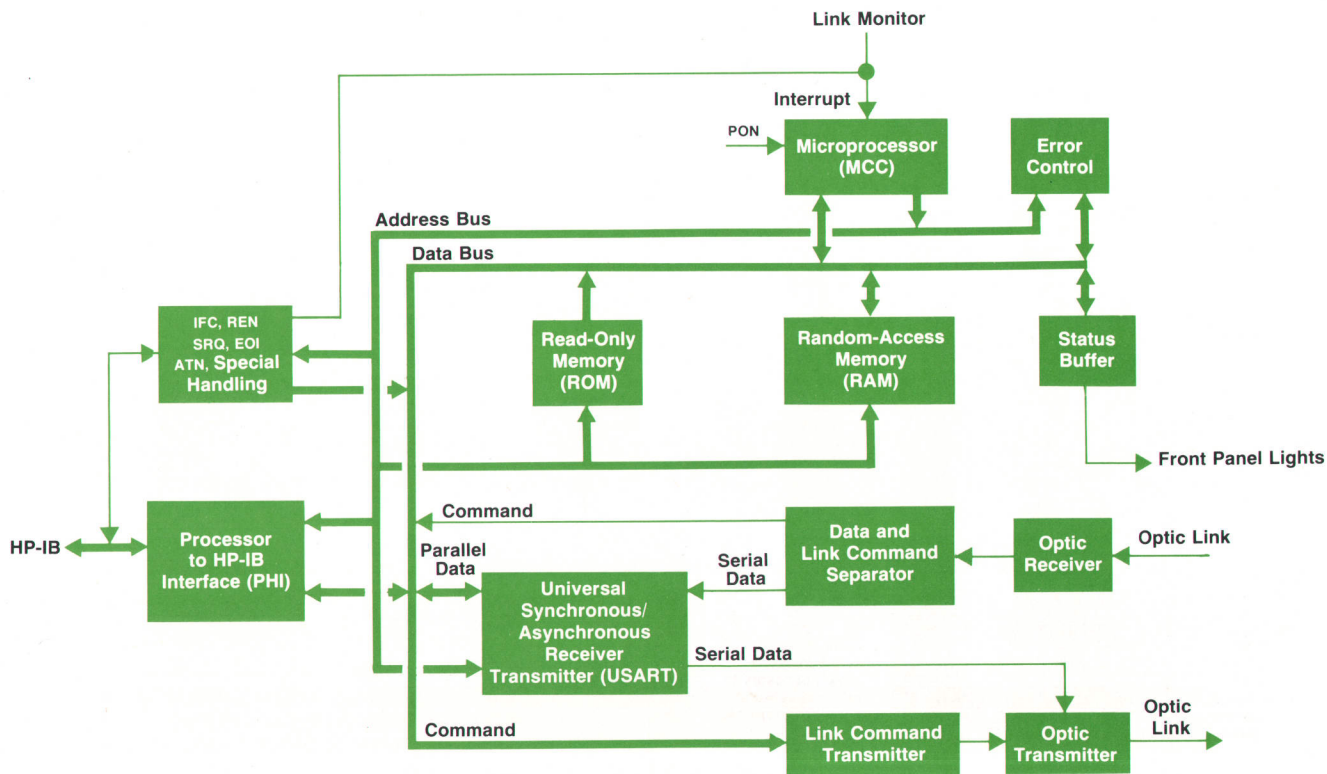


Fig. 6. Simplified 12050A block diagram. LSI functions are supplemented by discrete logic to maximize speed.

### DIAGNOSTIC REQUESTS

- S - Execute self-test at local and remote link units.
- L - Execute link test to verify correct operation of complete 12050A to 12050A link.
- E - Execute extended link test (link test executed 256 times).
- D - Down the link. Both local and remote 12050As are set off-line and do not interfere with any HP-IB transactions until IFC message is received via local HP-IB.

**Fig. 7.** Four system-level requests from the computer to the 12050A are used to determine the general status of the link. The down-link command has many uses.

these local and remote checksum error counts can be read to ensure that no partial degradation of the link has occurred. Each time the error counts are read, they are reset to zero.

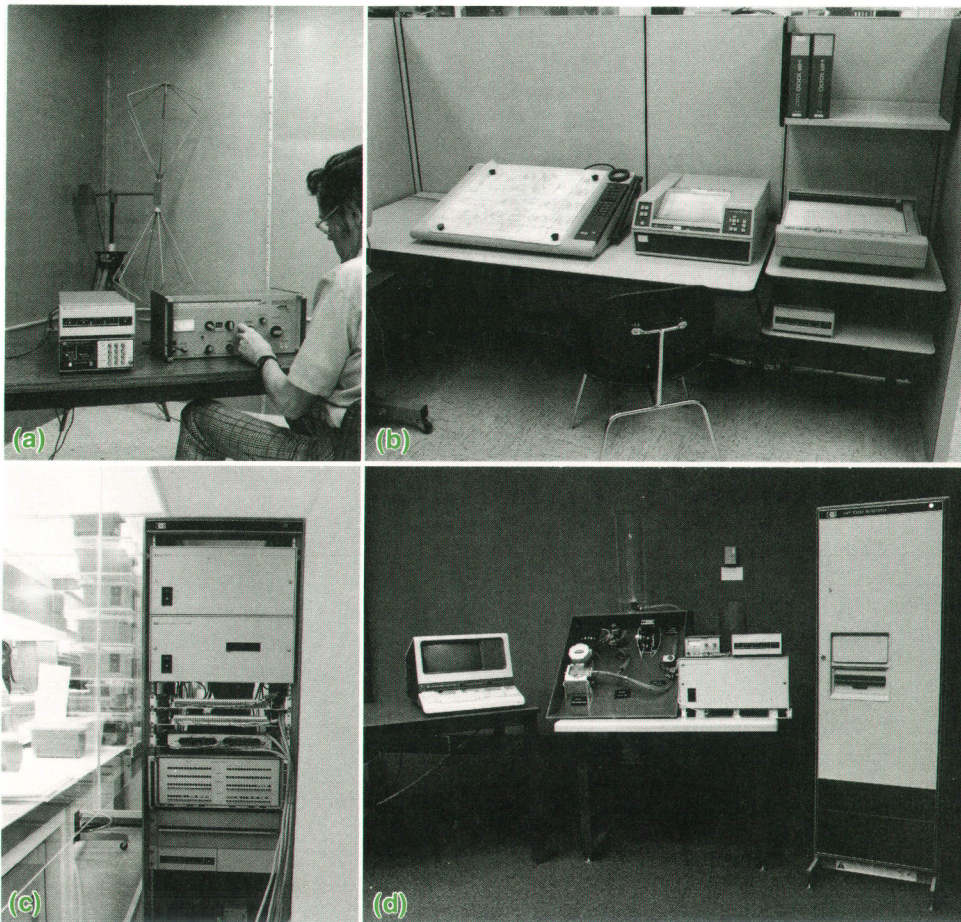
Besides monitoring integrity by counting checksum errors, the firmware attempts to report the cause of any irrecoverable error in the link. For example, when a link monitor error (generated by the fiber optic receiver module whenever the received light level falls below the minimum acceptable level) is detected by one of the 12050As, it causes a continuous flashing pattern in the front-panel lights.

The fourth system-level request, down link (D), is a useful tool in certain applications where it is advantageous temporarily to cease communications with remote HP-IB devices. The simplest case is when HP-IB data transfers faster than 20,000 bytes per second are desired at the local end of a link. Normally the data transfer can occur only at the rate of the slowest device on the bus, which in this case is the local 12050A. When the down link request is given before the higher-speed transfer, the local 12050A completely ignores the transaction.

Another use of the down link command is illustrated in Fig. 3. Where a group of instruments is identical to another group, even down to the individual HP-IB addresses, the two groups can be accessed alternately via two fiber optic links by alternately setting the links off-line.

### **Compatibility Testing**

The extensive use of HP-IB systems throughout HP provided an opportunity to characterize the performance of instrumentation systems interfaced via the 12050A Fiber Optic Link, and to ensure operation with a broad spectrum of applications. Tests were run at seven different HP divisions using demonstration programs, production test programs, lab development programs, and programs specifically developed for verifying HP-IB compatibility of other instruments. Over fifty different HP-IB compatible devices were used in one or more of the systems exercised. The performance of the 12050A during these tests has led to a



**Fig. 8.** Fiber optic link applications within HP. (a) The 12050A is used to reduce electrical noise in the vicinity of HP-IB instruments under test during screen room and RFI tests. (b) Numerous 12050As provide lab engineers with convenient printed hardcopy and graphics capabilities at or near their own desks. (c) A 2240A Measurement and Control Processor is used to control a metal-sputtering system in the production of silicon-on-sapphire circuits. Use of the 12050A allows the computer to be removed from the clean room environment for easy user access, while maintaining real-time processing capabilities. (d) One pair of 12050As connects an HP 1000 computer to a process control simulation in a demonstration room. Another pair of 12050As connects an HP 1000 in the same room to HP-IB instrumentation in various classrooms.



large number of HP applications, some of which are shown in Fig. 8.

At the same time, it was clear that many disc devices that are interfaced via the HP-IB use one feature of the HP-IB, parallel poll, that is not supported by the serially oriented 12050A. If those devices were to be used with the 12050A, their responses would have to be determined with the HP-IB serial poll feature.

### Acknowledgments

I want to express particular appreciation to Dick Cook, who was responsible for the complete hardware design of the 12050A and who helped investigate and categorize the wide variety of bus conditions we saw during the course of the project. Dave Hannebrink and Bill Dwyer also played key roles in maintaining project momentum and enthusiasm. Brice Clark helped provide project resources, King-Wah Yeung designed the power supply, Dennis Mitchell designed the 12050A package, and Steve Joseph aided with the firmware. Thanks to the many others who provided us support throughout the project. Special thanks to Virgil Laing, Geoff Chance, Dave Smith, Charlie Martin, Nick Kuhn, Don Mathiesen, Rich Irwin, Joe Williams and Allert Ligtenberg at other HP divisions for their support of our compatibility testing.

### Reference

1. Foreword to IEEE Std 488-1978, "IEEE Standard Digital Interface for Programmable Instrumentation."

### Robert B. Grady



Bob Grady, project manager and firmware designer for the 12050A, celebrates his tenth year with HP this month. In those ten years, he has managed development of the 2240A Measurement and Control Processor hardware, the HP ATLAS Compiler, software for automatic instrument calibration, and systems self-test. A native of Chicago, Illinois, Bob received his BSEE degree from Massachusetts Institute of Technology in 1965 and his MSEE degree from Stanford University in 1969. He and his wife, who is a programmer/analyst at HP, have a son and a daughter and live in Los Altos, California. Bob plays basketball and softball in local city recreation leagues and enjoys mountain vacations—hiking, camping or skiing.

## SPECIFICATIONS

### HP Model 12050A Fiber Optic HP-IB Link Units

**HP-IB DATA RATE:** 20,000 bytes/s maximum between 12050A units assuming continuous data transfer. Overall system performance is subject to HP-IB handshake rates of devices connected to the 12050As, the composition of commands and data being sent over the link, and the rate of transmitted errors between 12050A units. Typically the error rate between 12050A units will be low due to the highly secure fiber optic cable transmission medium and in most cases, will not affect system performance.

**SERVICE REQUEST RESPONSE:** Remote device service request (SRQ) asserted at local end of link typically within 100  $\mu$ s of its occurrence.

**ERROR DETECTION AND CORRECTION:** Detection of transmitted errors between 12050A units is done using a checksum byte comparison technique. If an error is detected, retransmission of the byte will occur until it is correctly received.

**CONFIGURATION CAPACITY:** Each 12050A unit is treated as an HP-IB device and is subject to HP-IB cabling and configuration restrictions imposed by the interface standard.

**CONNECTORS:** HP-IB connector is the standard IEEE 488-1978 24-pin female connector for use with HP 10631A/B/C/D HP-IB cables. Fiber optic connectors are precision ferrule optical connectors for use with 39200 Series Fiber Optic Cables (see Fiber Optic Cable specifications).

**HP-IB FUNCTION SUBSETS SUPPORTED:** SH1, AH1, T5, TE5, L3, LE3, SR1, RL1, PP0, DC1, DT1, C1, C2, C3, C4, C27. Controller functions parallel poll and pass control are not supported. (Refer to IEEE Std. 488-1978.)

**OVERALL SYSTEM COMPATIBILITY:** The HP 12050A Fiber Optic HP-IB Link has been designed to allow HP-IB devices to communicate with each other over long distances just as they would locally using standard HP-IB programming techniques and conventions. Extensive testing has been performed using a wide variety of HP-IB compatible instruments to ensure such operation.

#### POWER REQUIREMENTS:

VOLTAGE (ac single-phase): 86V to 127V; 172V to 254V.

FREQUENCY: 48 Hz to 66 Hz.

POWER CONSUMPTION: 15W.

**OPERATING TEMPERATURE:** 0 to 55°C.

**HUMIDITY:** 10 to 95% relative humidity non-condensing at 40°C.

#### PHYSICAL DIMENSIONS:

HEIGHT: 9 cm (3.5 in).

WIDTH: 21 cm (8.4 in).

DEPTH: 44 cm (17.4 in).

WEIGHT: 2.75 kg (6 lb 1 oz).

### 39200 Series Fiber Optic Cable

**OPERATING TEMPERATURE:** 0 to 70°C.

**STORAGE TEMPERATURE:** -40 to 85°C.

**RELATIVE HUMIDITY:** 95% at 70°C.

**MAXIMUM TENSILE FORCE ON CABLE:** 30 kg (66 lb) per channel

**MAXIMUM TENSILE FORCE ON CONNECTOR/CABLE:** 5 kg (11 lb).

**MINIMUM BEND RADIUS:** 7 mm (0.3 in).

**FLEXING:** 50000 cycles (180° bending at minimum bend radius).

**CRUSH LOAD:** 20 kg (44 lb).

**CABLE CONSTRUCTION:** Simplex (one-channel) and duplex (two-channel) cable, connectorized at each end. Each channel consists of a fused silica, slightly graded index, glass clad fiber (140  $\mu$ m diameter) surrounded by silicone coating, buffer jacket and tensile strength members. Outer jacket is polyurethane. The two channels of the duplex cable are connected by an easily separated zip cord structure which also provides channel identity by an extruded ridge on one side.

**WEIGHT:** 12 grams (0.43 oz) per metre - simplex

24 grams (0.85 oz) per metre - duplex

### Ordering Information

**HP 12050A FIBER OPTIC HP-IB LINK** unit (includes installation and Service Manual 12050-90001). Two 12050A units are required per remote application. Each pair of 12050A units requires one or two of the following fiber optic cable products. All 39200 Series cables are supplied with preassembled and pretested fiber optic connectors.

SIMPLEX (2 required per system)	DUPLEX (1 required per system)	
39201A	39201B	10-metre fiber optic cable
39202A	39202B	25-metre fiber optic cable
39203A	39203B	50-metre fiber optic cable
39204A	39204B	75-metre fiber optic cable
39205A	39205B	100-metre fiber optic cable

Only one cable length may be used to connect the 12050A units. Cable to cable interconnections are not permitted.

**PRICE IN U.S.A.:** 12050A, \$1950 each unit (two required per remote site).

**MANUFACTURING DIVISION:** DATA SYSTEMS DIVISION

11000 Wolfe Road

Cupertino, California 94014 U.S.A.

# A Picoammeter with Built-in, Synchronized Voltage Sources

*This new digital picoammeter makes measurements of small current with a resolution of  $10^{-15}$  amperes, and it provides programmable voltage steps and measurement delays for automatic I-V measurements on semiconductors, insulation materials, capacitors, printed-circuit boards, and other components.*

by Hitoshi Noguchi

**C**ONTINUING ADVANCES in technology have intensified the need for high-performance picoammeters to measure very small currents. These measurements are needed not only for evaluation of electronic components and electric materials, but also for the detection of physical and chemical phenomena. Many of these measurements also require adjustable voltage sources so current can be determined as a function of the applied voltage.

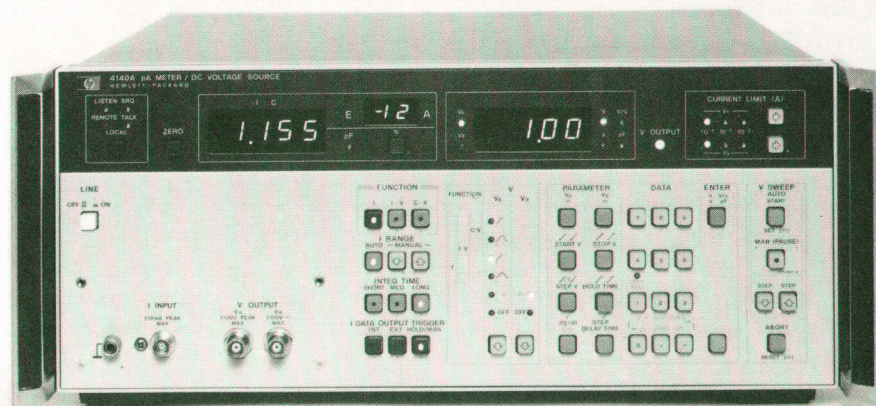
The new Model 4140A pA Meter/Dc Voltage Source was developed in response to these needs. It includes a sensitive picoammeter and two voltage sources, all managed by a microprocessor. One of the voltage sources can be programmed to step through a range of values and to hold at each step while the current is measured. The other voltage

source provides a fixed bias for measurements on devices such as transistors where two bias voltages are required. Previously, measurements of this nature were made with manually controlled instruments, consuming much time, or with automatic test systems that cost at least three or four times as much as the 4140A, in addition to requiring programming expertise.

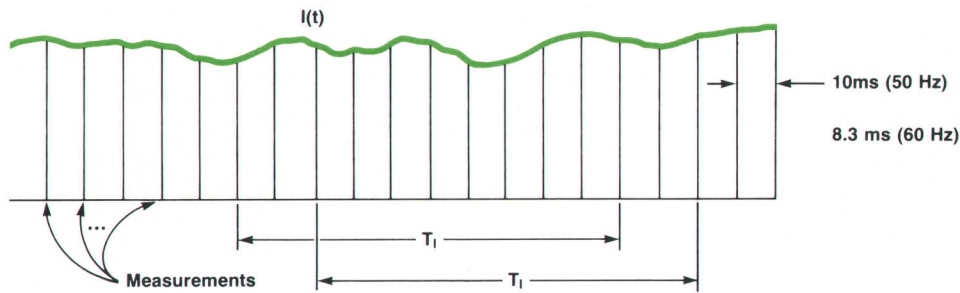
The 4140A can also be programmed to supply a ramp voltage to the device under test for quasi-static capacitance-versus-voltage measurements, a technique that is especially applicable to measurements on MOS capacitors.

## High Resolution with Stability

The pA meter in the 4140A is a floating, autoranging picoammeter that has full-scale ranges from  $\pm 1$  pA to  $\pm 10$



**Fig. 1.** Model 4140A pA Meter/Dc Voltage Source makes stable picoampere measurements with a maximum resolution  $1 \times 10^{-15}$  amperes. Two programmable voltage sources, one of which can step or sweep through a selected range, are provided for biasing the device under test. This instrument can also measure capacitances in a range of 0.1 to 1900 pF.



**Fig. 2.** Measurement fluctuations are smoothed by digitally averaging several readings. As each new measurement value is added, the oldest value is subtracted to maintain a running average.

mA ( $\pm 1 \times 10^{-12}$  to  $\pm 1 \times 10^{-2}$  amperes). The  $3\frac{1}{2}$ -digit readout gives a resolution of 1 femtoampere ( $10^{-15}$  A) on the most sensitive range. A zero offset cancels leakage currents in the test leads or fixtures of up to  $100 \times 10^{-15}$  amperes.

Measurement data is stabilized by digital averaging. To accommodate changing values, a moving average of the readings is kept with the oldest reading discarded when a new one is added (Fig. 2). The number of readings averaged (integration time) is selectable (short, medium, long) according to the desired meter response or expected measurement fluctuations. These times are automatically extended on the more sensitive ranges and shortened on the higher ranges to maintain the fastest response consistent with the measurement noise.

### Automatic Voltage Control

Each of the two programmable voltage sources spans  $\pm 100$  V in two ranges ( $\pm 100.00$ V,  $\pm 100.0$ V) and is capable of supplying up to 10 mA. Individually selectable current limits of  $10^{-4}$ ,  $10^{-3}$ , or  $10^{-2}$  amperes protect sensitive devices.

The ramp voltage provided by one of the sources is used for measurements of capacitance based on the relationship:

$$C = \frac{I}{dV/dt} \text{ farads.}$$

For example, if the ramp rate,  $dV/dt$ , is 0.01 V/s and the measured current is  $1.234 \times 10^{-12}$  A,

$$C = \frac{1.234 \times 10^{-12}}{0.01} = 123.4 \text{ pF.}$$

The details of the ramp are shown in Fig. 3a. The ramp slope is selectable from  $\pm 1$  mV/s to  $\pm 1$  V/s in 1-mV/s steps. The average ramp voltage during each measurement is displayed along with the current or capacitance data.

The details of the staircase voltage, used mainly for I-V

characterization, are shown in Fig. 3b. The voltage can be stepped in increments selectable with 0.01V or 0.1V resolution depending on the voltage range. The hold time is selected to allow time for the device or material under test to settle at the new voltage. The measurement time is determined by the selected integration time for the picoammeter.

### Low-Leakage Accessories

Great care must be exercised when connecting a picoammeter to a device for very-low-current measurements because leakage currents can degrade the measurement significantly. A set of cables (Fig. 4) is provided with the 4140A to minimize inaccuracies due to leakage. The cable for the current input is a low-noise triaxial cable that helps minimize leakage currents. Also available is an accessory test fixture (Fig. 5) that provides both electrostatic and light shielding for the device under test.

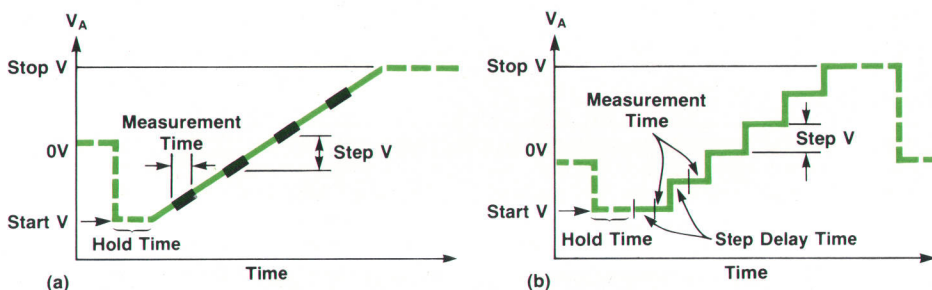
An option equips the 4140A to work with the HP Interface Bus\* so that all front-panel controls can be programmed remotely. With this option, measurement data can be sent to a controller for processing and then displayed in a variety of formats, an especially useful capability in a manufacturing environment where rapid feedback is desirable. Another option provides analog signals for driving an X-Y recorder.

Examples of the measurements that can be made with the 4140A are shown in Fig. 6. Fig. 6a is a typical C-V measurement plotted by a Model 9872A Digital Plotter under control of a Model 9825A Desktop Computer that also controls the 4140A through the HP-Interface Bus. Fig. 6b is an I-V measurement. Since the current varies over a wide range in this measurement, the autoranging feature of the 4140A proves to be especially useful. Fig. 6c is a plot of an I-V measurement in which both voltage sources are varied under program control.

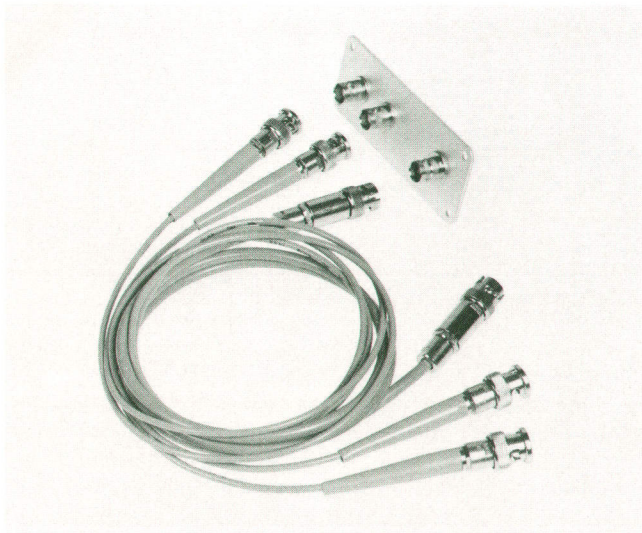
### Internal Details

A simplified block diagram of Model 4140A is shown in

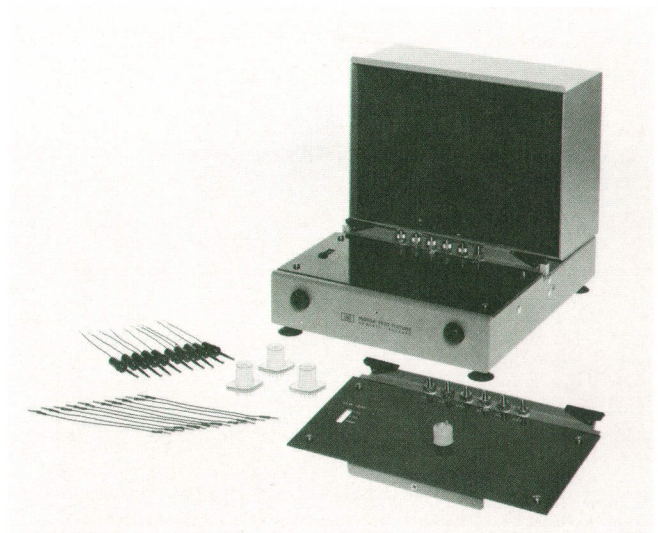
\*Hewlett-Packard's implementation of ANSI-IEEE 488/1978.



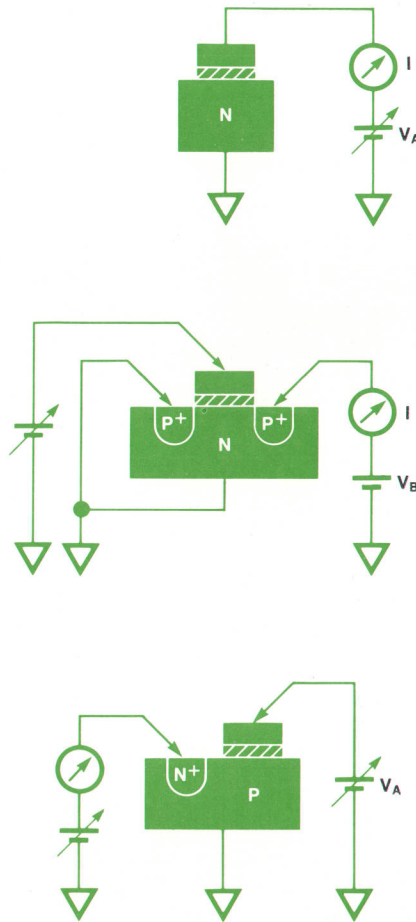
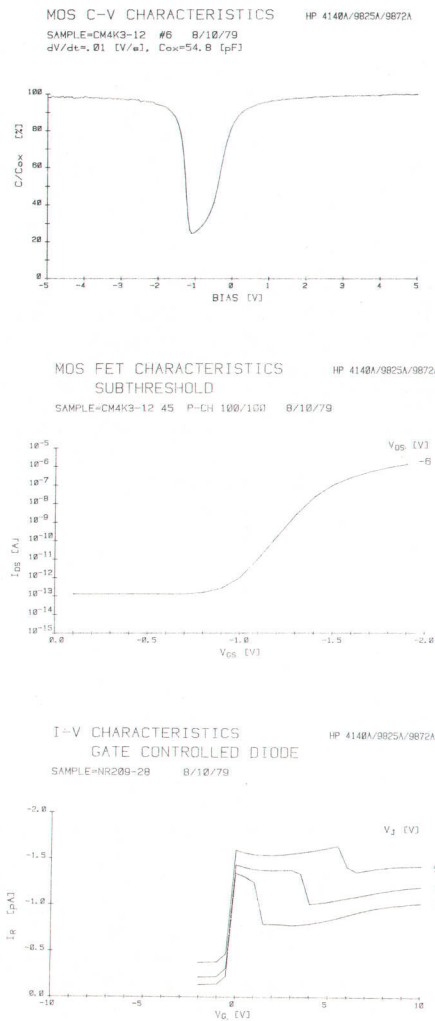
**Fig. 3.** (a) Details of the ramp voltage. The start and stop voltages, hold time, and ramp slope are selectable. The measurement time is determined by the picoammeter circuits. (b) Details of the staircase voltage.



**Fig. 4.** Test leads provided with the instrument include a low-noise triaxial cable for the current to be measured. A mounting plate for the user's test fixture is also provided.



**Fig. 5.** Accessory test fixture provides electrostatic and light shielding for the device under test. One connection plate is provided for use with the clip leads (included) and a second plate is provided for TO-5 type sockets.



**Fig. 6.** Typical measurements on semiconductors made with Model 4140A.

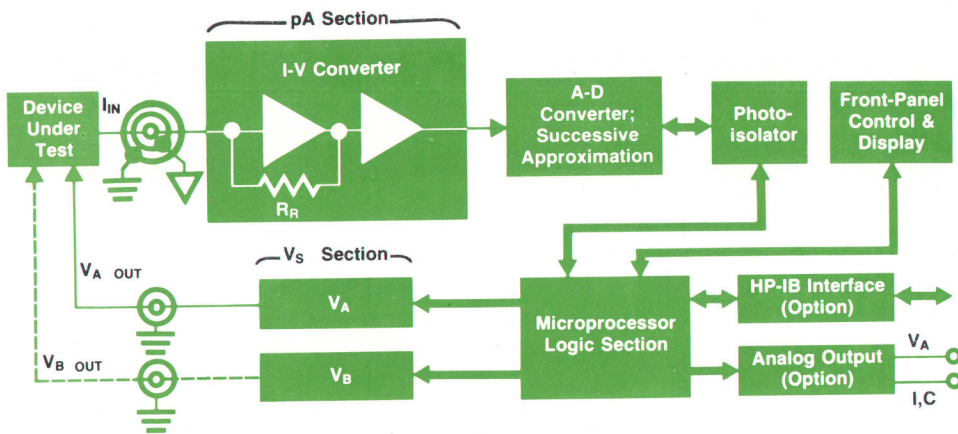


Fig. 7. Simplified block diagram of Model 4140A. All the analog controls and the data processing are managed by the microprocessor, an M6800.

Fig. 7. A current-to-voltage converter at the input generates a voltage proportional to the measured current for processing by conventional digital voltmeter circuits (in this case, a successive approximation A-to-D converter to achieve measurement speed). The basic I-to-V converter circuit, a type widely used in electronic pico-, micro-, and millimeters, is shown in Fig. 8. In this circuit, all of the input current flows through range resistor  $R_R$  while negative feedback keeps the amplifier input near zero. The amplifier's output impedance is low enough to drive succeeding circuits without disturbing the input source.

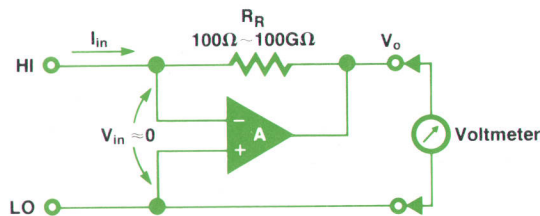


Fig. 8. Basic current-to-voltage converter uses feedback to maintain the input voltage near zero while the unknown current develops a measurable voltage across range resistor  $R_R$ .

Successful application of this circuit to a picoammeter requires exceptionally high amplifier input impedance and low offset. Since gain in an amplifier can be controlled precisely by generous amounts of negative feedback whereas dc offsets are not so easily controlled, it is common practice to convert a low-level dc input to an ac whose peak-to-peak excursions are proportional to the dc. After amplification to a level where offsets become insignificant, the ac is converted back to dc.

This technique is realized in the 4140A by the amplifier circuit diagrammed in Fig. 9. The voltage-variable capacitances,  $C_{V1}$  and  $C_{V2}$ —actually the gate capacitances of a dual-junction FET—and the center-tapped secondary of transformer T1 form a bridge, driven by a 500-kHz, 20-mV signal. The bridge is balanced when there is no input to the HI/LO terminals but when a dc voltage  $V_{in}$  appears at the input, one capacitance increases and the other decreases so the bridge becomes unbalanced. An ac voltage  $V_2$  then appears at the input to amplifier A1. This voltage is amplified in A1, reconverted to dc by the synchronous detector, and smoothed in integrator A2. Total gain from input to output ( $V_{in}$  to  $V_o$ ) is more than 100 dB.

Note that there is no dc path in the input circuit. This plus careful layout of the circuits surrounding the FET's achieves input bias currents of typically less than 3 fA and output

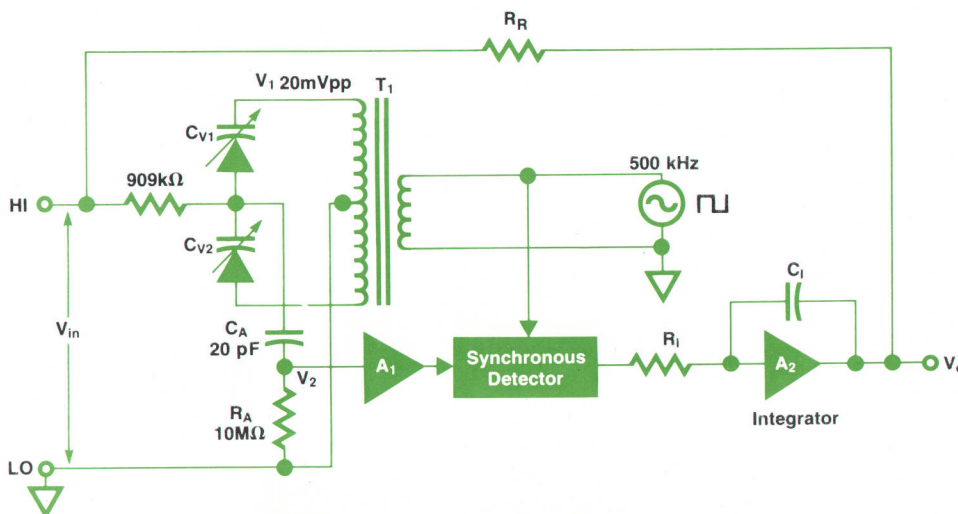
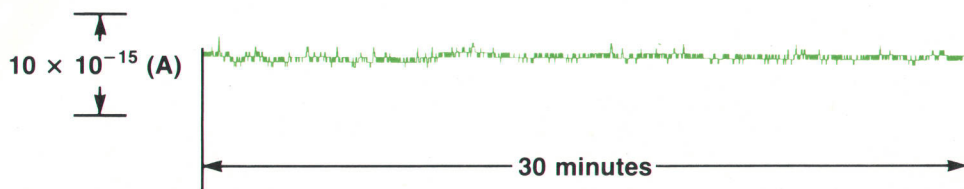


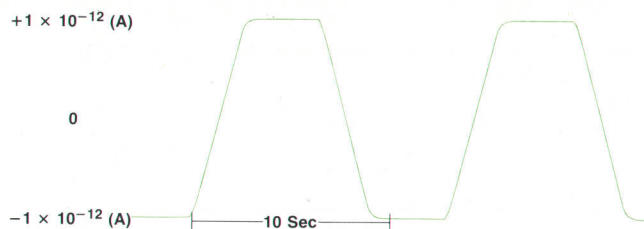
Fig. 9. The input amplifier used in the 4140A has a high dc input impedance since there is no dc path in the input circuit. In the absence of an input, the bridge formed by transformer T1 and capacitances  $C_{V1}$  and  $C_{V2}$  is balanced. An input voltage unbalances  $C_{V1}$  and  $C_{V2}$  differentially and an ac voltage,  $V_2$ , then appears at the input to amplifier A1.



**Fig. 10.** Recording demonstrates the stability of the 4140A on its most sensitive range. For this test, the source resistance was 100 G $\Omega$  and the measurement integration time was set to LONG.

offsets of less than 10  $\mu\text{V}/^\circ\text{C}$  at room temperatures. The feedback through range resistor  $R_R$ , however, makes the circuit input impedance appear low to the device under test. Fig. 10 shows the output stability when the instrument is on the most sensitive range and Fig. 11 shows the step response on the same range.

The front-panel zero offset is implemented digitally. When the ZERO button is pressed while the device under test is not connected, the displayed value of leakage current, or stray capacitance in the case of C-V measurements, is stored. This value is then subtracted from subsequent measurements.



**Fig. 11.** Step response of the Model 4140A, under the same conditions as the recording of Fig. 10, shows an absence of overshoot and other ambiguities. Similar clean response is obtained with the integration time set to MED and SHORT.

### Voltage Sources

The voltage sources are essentially stable power amplifiers driven by a digital-to-analog converter (DAC). Sample-and-hold techniques enable a single 12-bit DAC to drive both outputs and generate the stepped voltages.

Ramps are generated by an integrator in response to a step supplied by the DAC (Fig. 12). Ordinarily, the linearity of slow ramps is degraded by temperature variations that cause offset voltage drift in the integrator's amplifier. One

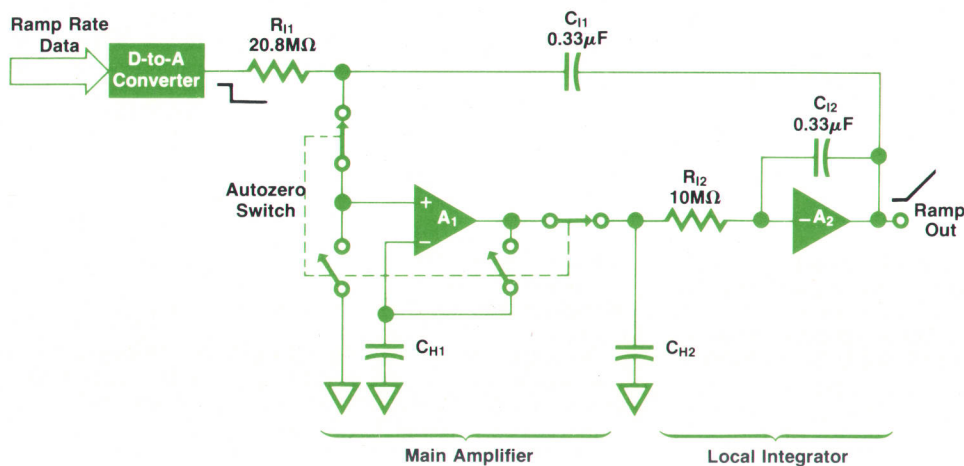
solution to this problem, often used in digital voltmeters, is to use an autozero operation. The autozero operation disconnects the input signal, grounds the amplifier input, and closes a negative feedback loop around the amplifier to a holding capacitor at the amplifier's inverting input. If the amplifier has an offset at the instant the switching takes place, the offset would start to charge the holding capacitor in the same direction as the offset, but since the capacitor voltage is applied to the amplifier's inverting input, the capacitor voltage tends to counteract the offset. As a result, the offset is reduced by a factor proportional to amplifier gain. The feedback loop is then opened and the offset correction voltage is retained on the capacitor.

To keep offset drift at negligible levels, an autozero operation should be performed at least once every 10 seconds. Since ramps generated by the 4140A may last hundreds of seconds, the ramp generator was designed to permit autozeroing at 10-second intervals without creating any discontinuities in the ramp. As shown in Fig. 12, the autozero operation is performed on main amplifier A1 and the offset correction voltage is retained on holding capacitor  $C_{H1}$ . A local integrator, A2, within the main integrator loop duplicates the ramp in response to the voltage that the main feedback loop places on holding capacitor  $C_{H2}$ . While the autozero operation is being performed with the main feedback loop open, A2 continues ramp generation in response to the voltage held on  $C_{H2}$ . Hence, no discontinuities are introduced into the ramp.

The overall amplification provided by A1 and A2 in cascade provides extremely high open-loop gain, minimizing any nonlinearity in the ramp.

### Acknowledgments

Yoshihisa Kameoka, who was the project leader during the early stages, was responsible for the pA section. Keiki Kanafuji also contributed to the pA section design. Susumu



**Fig. 12.** Ramp generator undergoes autozero operations for the main amplifier without disturbing the ramp in progress.

## PART 1: Chronological Index

### January 1979

- A Low-Cost, Microprocessor-Based 100-MHz Universal Counter, *Lewis W. Masters, Karl M. Blankenship, and Michael J. Ward*
- Lowest-Cost HP Universal Counter Developed Using LSI and Manufacturing Innovations, *Michael D. Wilson and David M. George*
- A High-Performance Bipolar LSI Counter Chip Using EFL and I<sup>2</sup>L Circuits, *Bosco W. Wong and William D. Jackson*
- A Synthesized Signal Source with Function Generator Capabilities, *Dan D. Danielson and Stanley E. Froseth*
- Viewpoints—Paul Baird on Electronic Equipment Reliability

### February 1979

- A High-Quality Digital X-Y Plotter Designed for Reliability, Flexibility and Low Cost, *John A. Fenoglio, Bessie W.C. Chin, and Terry R. Cobb*
- Linear Step Motor Design Provides High Plotter Performance at Low Cost, *Lung-Wen Tsai and Robert L. Ciardella*
- Developing a Low-Cost Electrostatic Chart-Hold Table, *Alec J. Babiarz*
- Simple, Efficient Electronics for a Low-Cost X-Y Plotter, *William G. Royce and Peter Chu*
- A Closed-Loop System for Smoothing and Matching Step Motor Responses, *Philip P. Maiorca and Norman H. MacNeil*
- Multi-Frequency LCR Meters Test Components under Realistic Conditions, *Kohichi Maeda and Yoh Narimatsu*

### March 1979

- Circuit-Board Testing: Cost Effective Production Test and Troubleshooting, *Peter S. Stone and John F. McDermid*
- Rapid Digital Fault Isolation with FASTRACE, *William A. Groves*
- Software Simulator Speeds Digital Board Test Generation, *Kenneth P. Parker*
- Virtual Memory for TESTAID and FASTRACE, *Douglas L. Baskins*
- Analog In-Circuit Component Measurements: Problems and Solutions, *David T. Crook*
- User-Oriented Software for an Automatic Circuit-Board Tester, *Ed O. Schlotzhauer*
- Testing the Tester, *Roland H. Burger, John J. Ketchum, Scott E. Woodward, and James M. Brown*
- Hardware Design of an Automatic Circuit Board Tester, *David T. Crook, Brian M. Wood, Francis F. Fiedler, Kamran Firooz, and Roland H. Burger*
- Board Testing with Signature Analysis, *Kamran Firooz*

### April 1979

- A Human-Engineered Small-Business Computer, *A. Peter Hamilton*
- Human-Engineering the Small-Business Computer, *Barry Mathis*
- Cost-Effective Electronics for the Small-Business Computer, *Gerald L. Meyer and V. DeLloy Forbes*
- HP 250 Input/Output System, *Dennis L. Peery*
- HP 250 BASIC: A Friendly, Interactive, Powerful System Language, *Dennis L. Peery*
- Low-Cost Data Base Management, *Michael V. Hetrick*
- Applications Software for the Small-Business Computer, *Scott W. Y. Wang and Loyd V. Nelson*
- Capacitance and Conductance Deep-Level Transient Spectroscopy Using HP-IB Instruments and a Desktop Computer, *Leonard Forbes and Ulrich Kaempf*

### May 1979

- A Precision, Programmable Pulse Generator, *Werner Hüttemann,*

- Lutz Kristen, and Peter Aue*
- Extending Possibilities in Desktop Computing, *Sandy L. Chumbley*
- Processor Enhancements Expand Memory, *Damon R. Ujvarosy and Dyke T. Shaffer*
- Designing to Meet Electromagnetic Interference Requirements, *John C. Becker*
- Assembly Programming Capability in a Desktop Computer, *Robert M. Hallissy*

### June 1979

- A Business Computer for the 1980s, *George R. Clark*
- The Integrated Display System and Terminal Access Method, *Eric P. L. Ha and James R. Groff*
- Reducing the Cost of Program Development, *Frederick W. Clegg*
- Managing Data: HP 300 Files and Data Bases, *Phillip N. Taylor, Alan T. Paré, and James R. Groff*
- An Easy-to-Use Report Generation Language, *Tu-Ting Cheng and Wendy Peikes*
- HP 300 Business BASIC, *May Y. Kovalick*
- Innovative Package Design Enhances HP 300 Effectiveness, *David A. Horine*

### July 1979

- Cost-Effective Hardware for a Compact Integrated Business Computer, *Arndt B. Bergh and Kenyon C. Y. Mei*
- A Computer Input/Output System Based on the HP Interface Bus, *W. Gordon Matheson*
- A Small, Low-Cost 12-Megabyte Fixed Disc Drive, *Richard L. Smith*
- An Innovative Programming and Operating Console, *Alfred F. Knoll and Norman D. Marschke*
- AMIGO/300: A Friendly Operating System, *Ralph L. Carpenter*
- Configuring and Launching the AMIGO/300 System, *Donald M. Wise and James C. McCullough*
- A Multiple-Output Switching Power Supply for Computer Applications, *Dilip A. Amin and Thane Kriegel*

### August 1979

- New Performance Standards in Microwave Spectrum Analysis, *Siegfried H. Linkwitz*
- Broadband Input Mixers for a Microwave Spectrum Analyzer, *John C. Lamy and Frank K. David*
- A Synthesized Microwave Local Oscillator with Continuous-Sweep Capability, *Larry R. Martin, Kenneth L. Lange, and Stephen T. Sparks*
- A Digital Pattern Generator for Functional Testing of Bus-Oriented Digital Systems, *Günter Riebesell, Ulrich Hübner, and Bernd Moravek*
- An HP-IB Extender for Distributed Instrument Systems, *David H. Guest*

### September 1979

- SOS Technology Yields Low-Cost HP 3000 Computer System, *Richard C. Edwards*
- Adapting the Multiprogramming Executive to a New Hardware Environment, *Claude Robinson, Jr.*
- A Friendly, Easy-to-Service Computer, *Yas Matsui and Manmohan Kohli*
- A Remote Computer Troubleshooting Facility, *David L. Nelson*
- Philosophy of HP 3000 Series 33 Diagnostics, *James H. Holl*
- Controlling Electromagnetic Interference Generated by a Computer System, *Daniel T.Y. Wong*
- Automated Pulmonary Function Measurements, *Maurice R. Blais*

and John L. Fanton  
Triggered X-Y Oscilloscope Displays, P. Guy Howard

**October 1979**

Microprocessor Lab Teaches Operation and Troubleshooting,  
Barry Bronson and Michael Slater  
An Economical Network Analyzer for the 4-to-1300-MHz Range,  
James R. Zellers  
Expanding Logic Analyzer Capabilities by Means of the HP-IB,  
Robert G. Wickliff, Jr. and Richard A. Nygaard, Jr.  
A Serial Data Analyzer for Locating Faults in Decentralized Digital  
Systems, Robert E. Erdmann, Jr.

**November 1979**

Precise, Convenient Analysis of Modulated Signals, Allen P.  
Edwards  
IF Filters for the 8901A Modulation Analyzer, Andrew H. Naegeli  
A New Type of FM Demodulator, Russell B. Riley  
Modulation Analyzer Applications, Allen P. Edwards  
Assuring Accuracy in Modulation Measurements, Leslie E.

**Brubaker**

Interactive Modulation Analyzer Control, Paul J. Lingane  
Special Signal Source Tests Modulation Analyzer, Leslie E.  
Brubaker

**December 1979**

High-Speed Fiber Optic Link Provides Reliable Real-Time HP-IB  
Extension, Robert B. Grady  
A Ready-to-Use Fiber Optic Link for Data Communications,  
Delon C. Hanson  
A Picoammeter with Built-in, Synchronized Voltage Sources,  
Hitoshi Noguchi  
Annual Index  
Personal Calculator Has Key to Solve Any Equation  $f(x)=0$ , William  
Kahan  
Viewpoints—Don Loughry on ANSI/IEEE Standard 488 and the  
HP Interface Bus  
Four Color Plotters Enhanced for Unattended Operation, Majid  
Azmoon, Randy A. Coverstone, and Richard M. Kemplin

# PART 2: Subject Index

Month/Year	Subject	Model
<b>A</b>		
Feb. 1979	Accelerometer, hybrid	
Apr. 1979	Accounts receivable,	HP 250
May 1979	Address extension chip	
Sept. 1979	Air flow measurements in the pulmonary lab	47804S
July 1979	AMIGO/300 operating system	HP 300
Nov. 1979	Amplitude modulation measurements	8901A
May 1979	Assembly language, desktop computer	9835A
July 1979	Asynchronous data communications controller	31264A
Mar. 1979	Automatic circuit board testing	DTS/70,3060A
Dec. 1979	Automatic paper advance, X-Y plotter	9872S,7221S,7220S
<b>B</b>		
June 1979	BASIC, business computer	HP 300
Apr. 1979	BASIC, business computer	HP 250
May 1979	BASIC, desktop computer	9835A
Jan. 1979	Battery-powered universal counter	5314A,5315A
Jan. 1979	Bipolar integrated circuit chip, MRC	
Mar. 1979	Board test language	9825A/3060A
Mar. 1979	Board testing, automatic	DTS/70,3060A
Dec. 1979	Bus extender, fiber optic	12050A
Aug. 1979	Bus extender, telephone compatible	37201A
Apr. 1979	Business computer, entry level	HP 250
June 1979	Business computer	HP 300
July 1979	Business computer	HP 300
Sept. 1979	Business computer	HP 3000 Series 33
<b>C</b>		
Dec. 1979	Calculator, handheld	HP-34C
Apr. 1979	Capacitance DLTS	
Dec. 1979	Capacitance/voltage measurements	4140A
Mar. 1979	Circuit-board testing, automatic	DTS/70,3060A
Oct. 1979	Communications, data analyzer	1640A
June 1979	Computer, business	HP 300
July 1979	Computer, business	HP 300
May 1979	Computer, desktop	9835A
July 1979	Computer power supply	63312F
Apr. 1979	Computer, small-business	HP 250
Sept. 1979	Computer system, low-cost general-purpose	HP 3000 Series 33
Apr. 1979	Conductance DLTS	
Feb. 1979	Control system, linear step motor	7225A
May 1979	Controller, desktop	9835A

Jan. 1979	Counter chip, multiple-register	
Jan. 1979	Counter, universal, 100-MHz, low-cost	5314A
Jan. 1979	Counter, universal, 100-MHz, reciprocal	5315A/B
Dec. 1979	Current measurements, picoampere	4140A

**D**

Apr. 1979	Data base management	HP 250
June 1979	Data base management	HP 300
Oct. 1979	Data communications analyzer	1640A
Apr. 1979	Deep-level transient spectroscopy (DLTS)	
May 1979	Desktop computer	9835A
Feb. 1979	Digital LCR meters, multifrequency	4274A/75A
Aug. 1979	Digital pattern generator	8170A
Feb. 1979	Digital X-Y plotter	7225A
Nov. 1979	Discriminator, charge count	8901A
Aug. 1979	Discriminator with controllable slope	8566A
July 1979	Disc drive, Winchester type	HP 300, 7910K
June 1979	Display, integrated	HP 300
July 1979	Display, integrated	HP 300
Sept. 1979	Displays, X-Y, selectively blanked	1741A/002

**E**

Sept. 1979	Electromagnetic interference suppression, computer	HP 3000 Series 33
May 1979	EMI design	9835A
Jan. 1979	Emitter function logic (EFL)	
Dec. 1979	Equation solver, handheld calculator	HP-34C
Dec. 1979	Extender, HP Interface Bus, fiber optic	12050A
Aug. 1979	Extender, HP Interface Bus, telephone	37201A

**F**

Mar. 1979	FASTRACE	DTS/70
Mar. 1979	Fault isolation in analog circuit boards	3060A
Mar. 1979	Fault isolation in digital circuit boards	DTS/70
Dec. 1979	Fiber optic HP-IB link	12050A
Nov. 1979	FM discriminator, charge count	8901A
Aug. 1979	FM discriminator, controllable slope	8566A
Nov. 1979	Frequency measurements	8901A
Jan. 1979	Frequency measurements to 100 MHz	5314A,5315A/B
Nov. 1979	Frequency modulation measurements	8901A
Jan. 1979	Function generator/synthesizer, 0 to 21 MHz	3325A

**G**

July 1979	General I/O channel	31262A
Aug. 1979	Generator, logic pattern	8170A



May 1979 Generator, pulse, programmable 8160A

### H

Dec. 1979 HP-IB extender, fiber optic 12050  
Aug. 1979 HP-IB extender, telephone 37201A  
Oct. 1979 HP-IB interface for logic analyzers 1610A/003,1615A/001

### I

Apr. 1979 IMAGE/250 HP 250  
June 1979 IMAGE/300 HP 300  
Mar. 1979 In-circuit board testing 3060A  
Aug. 1979 Instrument systems, HP-IB extender for 37201A  
Jan. 1979 Integrated-circuit chip, bipolar, MRC  
June 1979 Integrated display system HP 300  
July 1979 Integrated display system HP 300  
Jan. 1979 Integrated injection logic (I<sup>2</sup>L)  
Dec. 1979 Interface bus extender, fiber optic 12050A  
Aug. 1979 Interface bus extender, telephone 37201A  
Apr. 1979 Inventory control HP 250

### L

June 1979 Language subsystem HP 300  
Feb. 1979 LCR meters, multifrequency 4274A,4275A  
Feb. 1979 Linear step motor plotter 7225A  
Oct. 1979 Logic analyzers, HP-IB interfaces for 1610A/003,1615A/001  
Aug. 1979 Logic pattern generator 8170A  
Sept. 1979 Lung function measurements 47804S

### M

Apr. 1979 Manufacturing reporting HP 250  
Oct. 1979 Microprocessor lab 5036A  
Aug. 1979 Microwave spectrum analyzer 8566A  
Nov. 1979 Modulation analyzer 8901A  
Oct. 1979 Monitor/simulator/analyzer for data communications 1640A  
Jan. 1979 Multiple-register counter (MRC) chip  
Sept. 1979 Multiprogramming executive operating system HP 3000 Series 33

### N

Oct. 1979 Network analyzer, 4 to 1300 MHz 8754A

### O

July 1979 Operating system, AMIGO/300 HP 300  
Sept. 1979 Operating system, MPE-III HP 3000  
Apr. 1979 Order entry HP 250  
Sept. 1979 Oscilloscopes, selectively blanked X-Y displays 1741A/002  
Aug. 1979 Oscillator, local, synthesized sweeping 8566A

### P

Dec. 1979 Paper advance,automatic X-Y plotter 9872S,7221S,7220S  
Jan. 1979 Period measurements 5314A,5315A/B  
Nov. 1979 Phase modulation measurements 8901A  
Dec. 1979 Picoammeter/dc voltage source synchronized 4140A  
Feb. 1979 Plotter, digital X-Y 7225A  
Dec. 1979 Plotter, X-Y, with paper advance 9872S,7221S,7220S  
Sept. 1979 Pneumotach for pulmonary measurements 47804S  
Jan. 1979 Portable universal counters 5314A,5315A  
Nov. 1979 Power measurements 8901A  
July 1979 Power supply, computer 63312F  
Oct. 1979 "Practical Microprocessors" (coursebook) 5036A  
May 1979 Pulse generator, 50 MHz, programmable 8160A  
Aug. 1979 Pulse generator, logic patterns 8170A  
Sept. 1979 Pulmonary function measurements, automated 47804S

### R

Jan. 1979 Ramp generator, precision; synthesizer/function generator 3325A  
Jan. 1979 Ratio measurements 5314A,5315A/B  
Dec. 1979 Recorder, X-Y, with paper advance 9872S,7221S,7220S  
Jan. 1979 Reliability in electronic equipment  
Sept. 1979 Remote computer troubleshooting HP 3000 Series 33  
Nov. 1979 RF modulation measurements 8901A  
Oct. 1979 RF Network Analyzer 4 to 1300 MHz 8754A  
Dec. 1979 Root finder, handheld calculator HP-34C  
June 1979 RPG, business computer HP 300

### S

Apr. 1979 Sales analysis HP 250  
Apr. 1979 Semiconductor process development, DLTS system  
Oct. 1979 Serial data analyzer 1640A  
June 1979 Shipping container HP 300  
Nov. 1979 Signal generator 11715A  
Jan. 1979 Signal source, programmable synthesizer/function generator, 0 to 21 MHz 3325A  
June 1979 Silicon-on-sapphire processor HP 300  
July 1979 Silicon-on-sapphire processor HP 300  
Dec. 1979 SOLVE: equation solver HP-34C  
Sept. 1979 SOS processor HP 3000 Series 33  
Mar. 1979 Simulator for digital board testing, TESTAID DTS-70  
Nov. 1979 Source, AM/FM 11715A  
Aug. 1979 Source, logic pattern 8170A  
May 1979 Source, pulses, programmable 8160A  
Aug. 1979 Spectrum analyzer, 100 Hz to 22 GHz 8566A  
Feb. 1979 Step motors, linear 7225A  
Jan. 1979 Synthesis, frequency, fractional-N 3325A  
Jan. 1979 Synthesizer/function generator, 0 to 21 MHz 3325A  
May 1979 System 35, 9800 Series 9835A  
Aug. 1979 Systems, HP-IB extender for 37201A  
Dec. 1979 Systems, HP-IB extender for 12050A

### T

Mar. 1979 TESTAID program generator for digital board testing DTS-70  
Jan. 1979 Time-interval measurements 5314A,5315A/B  
Sept. 1979 Triggered X-Y oscilloscope displays 1741A/002  
Mar. 1979 Troubleshooting circuit boards automatically DTS/70-3060A  
Sept. 1979 Troubleshooting, computer, remote HP 3000 Series 33  
Oct. 1979 Troubleshooting, microprocessor, training 5036A

### U

Jan. 1979 Universal counter, 100-MHz, low-cost 5314A  
Jan. 1979 Universal counter, 100-MHz, reciprocal 5315A/B

### V

Nov. 1979 VCO measurements 8901A  
July 1979 Virtual memory operating system HP 300  
Mar. 1979 Virtual memory for digital board tester DTS-70

### X

Sept. 1979 X-Y displays, selectively blanked 1741A/002  
Feb. 1979 X-Y plotter 7225A  
Dec. 1979 X-Y plotters with paper advance 9872S,7221S,7220S

### Y

Aug. 1979 YIG-tuned mixer 8566A

### Z

# PART 3: Model Number Index

Model	Product	Month/Year	7220S	7221S	7225A	7910K	8160A	8170A	8566A	8754A	8901A	9835A/B	9872S	11715A	12050A	31262A	31264A	37201A	47804A/S	63312F		
HP-34C	Calculator	Dec. 1979																			Plotter	Dec. 1979
System 35	Desktop Computer (9835A)	May 1979																			Plotter	Dec. 1979
DTS-70	Digital Test System	Mar. 1979																			Plotter	Feb. 1979
HP 250	Small-Business Computer	Apr. 1979																			Disc Drive	July 1979
HP 300	Computer	June 1979																			Programmable Pulse Generator	May 1979
1610A/003	Logic State Analyzer with HP-IB	July 1979																			50-MHz	
1615A/001	Logic Analyzer with HP-IB	Oct. 1979																			Logic Pattern Generator	Aug. 1979
1741A/002	Oscilloscope (triggered X-Y display)	Sept. 1979																			Spectrum Analyzer	Aug. 1979
HP 3000, Series 33	Computer System	Sept. 1979																			100-Hz-2.5 GHz/2-22 GHz	
3060A	Board Test System	Mar. 1979																			Network Analyzer,	Oct. 1979
3325A	Synthesizer/Function Generator	Jan. 1979																			4 to 1300 MHz	
4140A	pA Meter/Dc Voltage Source	Dec. 1979																			Modulation Analyzer	Nov. 1979
4271A/B	LCR Meter (in DLTS System)	Apr. 1979																			Desktop Computer	May 1979
4274A	LCR Meter, 100 Hz-100 kHz	Feb. 1979																			Plotter	Dec. 1979
4275A	LCR Meter, 10 kHz-10 MHz	Feb. 1979																			AM/FM Test Source	Nov. 1979
5036A	Microprocessor Lab	Oct. 1979																			Fiber Optic HP-IB Link	Dec. 1979
5314A	100-MHz Universal Counter	Jan. 1979																			General I/O Channel	July 1979
5315A/B	100-MHz Universal Counter	Jan. 1979																			Asynchronous Data	July 1979
																					Communications Controller	
																					HP-IB Extender	Aug. 1979
																					Pulmonary Measurement	Sept. 1979
																					Systems	
																					Power Supply	July 1979

# PART 4: Author Index

Author	Month/Year	Author	Month/Year	Author	Month/Year
<b>A</b>		Groff, James R.	June 1979	<b>N</b>	
Amin, Dilip A.	July 1979	Groves, William A.	Mar. 1979	Naegeli, Andrew H.	Nov. 1979
Aue, Peter	May 1979	Guest, David H.	Aug. 1979	Narimatsu, Yoh	Feb. 1979
<b>B</b>		<b>H</b>		Nelson, David L.	Sept. 1979
Babiarz, Alec J.	Feb. 1979	Ha, Eric P.L.	June 1979	Nelson, Loyd V.	Apr. 1979
Baird, Paul	Jan. 1979	Hallissy, Robert M.	May 1979	Noguchi, Hitoshi	Dec. 1979
Baskins, Douglas L.	Mar. 1979	Hamilton, A. Peter	Apr. 1979	Nygaard, Richard A., Jr.	Oct. 1979
Becker, John C.	May 1979	Hanson, Delon C.	Dec. 1979	<b>P</b>	
Bergh, Arndt B.	July 1979	Hetrick, Michael V.	Apr. 1979	Paré, Alan T.	June 1979
Blais, Maurice R.	Sept. 1979	Holl, James H.	Sept. 1979	Parker, Kenneth P.	Mar. 1979
Blankenship, Karl M.	Jan. 1979	Horine, David A.	June 1979	Peery, Dennis L.	Apr. 1979
Bronson, Barry	Oct. 1979	Howard, P. Guy	Sept. 1979	Peikes, Wendy	June 1979
Brown, James M.	Mar. 1979	Hübner, Ulrich	Aug. 1979	<b>R</b>	
Brubaker, Leslie E.	Nov. 1979	Hüttemann, Werner	May 1979	Riebesell, Günter	Aug. 1979
Burger, Roland H.	Mar. 1979	<b>J</b>		Riley, Russell B.	Nov. 1979
<b>C</b>		Jackson, William D.	Jan. 1979	Robinson, Claude, Jr.	Sept. 1979
Carpenter, Ralph L.	July 1979	<b>K</b>		Royce, William G.	Feb. 1979
Cheng, Tu-Ting	June 1979	Kaempff, Ulrich	Apr. 1979	<b>S</b>	
Chin, Bessie W.C.	Feb. 1979	Kahan, William	Dec. 1979	Schlotzhauer, Ed O.	Mar. 1979
Chu, Peter	Feb. 1979	Ketchum, John J.	Mar. 1979	Shaffer, Dyke T.	May 1979
Chumbley, Sandy L.	May 1979	Knoll, Alfred F.	July 1979	Slater, Michael	Oct. 1979
Ciardella, Robert L.	Feb. 1979	Kohli, Manmohan	Sept. 1979	Smith, Richard L.	July 1979
Clark, George R.	June 1979	Kovalick, May Y.	June 1979	Sparks, Stephen T.	Aug. 1979
Clegg, Frederick W.	June 1979	Kriegel, Thane	July 1979	Stone, Peter S.	Mar. 1979
Cobb, Terry R.	Feb. 1979	Kristen, Lutz	May 1979	<b>T</b>	
Crook, David T.	Mar. 1979	<b>L</b>		Taylor, Phillip N.	June 1979
<b>D</b>		Lamy, John C.	Aug. 1979	Tsai, Lung-Wen	Feb. 1979
Danielson, Dan D.	Jan. 1979	Lange, Kenneth L.	Aug. 1979	<b>U</b>	
David, Frank K.	Aug. 1979	Lingane, Paul J.	Nov. 1979	Ujvarosy, Damon R.	May 1979
<b>E</b>		Linkwitz, Siegfried H.	Aug. 1979	<b>W</b>	
Edwards, Allen P.	Nov. 1979	<b>M</b>		Wang, Scott W.Y.	Apr. 1979
Edwards, Richard C.	Sept. 1979	MacNeil, Norman H.	Feb. 1979	Ward, Michael J.	Jan. 1979
Erdmann, Robert E., Jr.	Oct. 1979	Maeda, Kohichi	Feb. 1979	Wickliff, Robert G., Jr.	Oct. 1979
<b>F</b>		Maiorca, Philip P.	Feb. 1979	Wilson, Michael D.	Jan. 1979
Fanton, John L.	Sept. 1979	Marschke, Norman D.	July 1979	Wise, Donald M.	July 1979
Fenoglio, John A.	Feb. 1979	Martin, Larry R.	Aug. 1979	Wong, Bosco W.	Jan. 1979
Fiedler, Francis F.	Mar. 1979	Masters, Lewis W.	Jan. 1979	Wong, Daniel T.Y.	Sept. 1979
Firooz, Kamran	Mar. 1979	Matheson, W. Gordon	July 1979	Wood, Brian M.	Mar. 1979
Forbes, Leonard	Apr. 1979	Mathis, Barry	Apr. 1979	Woodward, Scott E.	Mar. 1979
Forbes, V. DeLloyd	Apr. 1979	Matsui, Yas	Sept. 1979	<b>Z</b>	
Froseth, Stanley E.	Jan. 1979	McCullough, James C.	July 1979	Zellers, James R.	Oct. 1979
<b>G</b>		McDermid, John F.	Mar. 1979		
George, David M.	Jan. 1979	Mei, Kenyon C.Y.	July 1979		
Grady, Robert B.	Dec. 1979	Meyer, Gerald L.	Apr. 1979		
		Moravek, Bernd	Aug. 1979		

Takagi and Minoru Niizaki designed the voltage sources, and Fumiroh Tsuruda and Hisao Yoshino designed the digital section. Mechanical design was by Yoshimasa Shibata and industrial design by Kazunori Shibata. Yoshio Sato designed the accessories. We would also like to thank Takuo Banno, who gave much useful advice on design and evaluation of the prototypes, and the many other people who made significant contributions to the project.



### Hitoshi Noguchi

Hitoshi Noguchi graduated from Akita University in 1961 and joined Yokogawa Electric Works that same year, working as an R and D engineer on signal generator development. He transferred to Yokogawa-Hewlett-Packard in 1964 where he worked on the 4260A Universal Bridge, the 4270A Capacitance Bridge, the 4271A LCR Meter, among others, before becoming project leader for the 4140A. Outside of working hours, Hitoshi likes to go hiking and cycling, or listening to classical music.

## ABBREVIATED SPECIFICATIONS

### HP Model 4140A pA Meter/DC Voltage Source

#### MEASUREMENT FUNCTIONS: I, I-V and C-V.

I: Independent picoammeter and programmable voltage source.

I-V: I-V characteristic measurements.

C-V: Quasi-static C-V characteristic measurement.

VOLTAGE SOURCES:  $V_A$  and  $V_B$ .

Function	$V_A$	$V_B$
I		
I-V		
C-V		

VOLTAGE SWEEP: Auto or manual (pause).

#### DISPLAYS:

CURRENT: 3½ digits with 2-digit annunciator.

VOLTAGE: 3½ digits.

### Current Measurements

RANGE:  $\pm 1.000 \times 10^{-12}$  A to  $\pm 1.000 \times 10^{-2}$  A full scale in 11 ranges, auto or manual ranging, 90% overrange.

#### ACCURACY/INTEGRATION TIME:

Range	Accuracy $\pm$ (% of rdg. + counts)	Integration Time (ms)		
		Short	Medium	Long
$10^{-2}$ - $10^{-9}$	0.5 + 2	20	80	320
$10^{-10}$	2 + 2			
$10^{-11}$	5 + 3	80	320	1280
$10^{-12}$	5 + 8	160	640	2560

VOLTAGE BURDEN:  $\leq 10 \mu\text{V}$  at full scale.

ZERO OFFSET RANGE: 0 to  $\pm 100 \times 10^{-15}$  A.

TRIGGER (Output I Data): INT, EXT and HOLD MAN.

HIGH-SPEED I DATA OUTPUT: Available with HP-IB option. Maximum rate: 2.5 ms intervals.

### Capacitance-Voltage (C-V) Measurement

RANGE: 0.0 pF to 1900 pF, auto-ranging.

ZERO OFFSET RANGE: 0 to 100 pF.

%C RANGE: 0.0% to 199.9% (Capacitance change in device under test is displayed as a percent of the set value of the oxide capacitance;  $C_{ox} = 100\%$ ).

### DC Voltage Sources

RANGES ( $V_A$  AND  $V_B$ ): 0 to  $\pm 100.0$  V.

MAXIMUM CURRENT: 10 mA, both sources.

VOLTAGE SWEEP: Auto and manual (pause), up/down step in manual (pause) mode.

Sweep abort enables reset.

#### PARAMETER SETTING RANGES:

START/STOP V: 0 to  $\pm 10.00$  V, 0.01 V steps; 0 to  $\pm 100.0$  V, 0.1 V steps.

STEP V: 0 to  $\pm 10.00$  V, 0.01 V steps; 0 to  $\pm 100.0$  V, 0.1 V steps.

HOLD TIME: 0 to 199.9 s, 0.1-s steps; 0 to 1999 s, 1-s steps.

STEP DELAY TIME: 0 to 10.00 s, 0.01-s steps; 0 to 100.0 s, 0.1-s steps.

dV/dt (ramp rate): 0.001 V/s to 1.000 V/s, 0.001-V/s steps.

CURRENT LIMITING: 100  $\mu\text{A}$ , 1 mA, and 10 mA,  $\pm 10\%$ ( $V_A$  and  $V_B$ ).

### General

OPERATING TEMPERATURE: 0°C to 40°C.

RELATIVE HUMIDITY:  $\leq 70\%$  at 40°C.

POWER: 100, 120, 220V,  $\pm 10\%$ ; 240V + 5% - 10%; 48-66 Hz, 135 V<sub>A</sub> maximum with any option.

DIMENSIONS: 426 mm W  $\times$  177 mm H  $\times$  498 mm D (16.5  $\times$  7  $\times$  19.6 in).

WEIGHT: 14.2 kg (31.2 lb).

ACCESSORY FURNISHED: 16053A Test Leads. Triaxial cable, two each BNC-BNC cables and one connection plate.

OPTIONS: 001 Analog Output (I, C and V) with pushbutton scaling.  
101 HP-IB Interface.

#### ACCESSORIES AVAILABLE:

16053A Test leads.

16054A Connection selector.

16055A Test fixture, general-purpose.

16056A Current divider (10:1).

PRICES IN U.S.A.: 4140A, \$7360; Opt 001, \$325; Opt 101, \$220; 16053A, \$320;

16054A, \$275; 16055A, \$1250; 16056A, \$140.

MANUFACTURING DIVISION: YOKOGAWA-HEWLETT-PACKARD LTD.

9-1, Takakura-cho, Hachioji-shi  
Tokyo, Japan, 192

# Personal Calculator Has Key to Solve Any Equation $f(x) = 0$

The HP-34C is the first handheld calculator to have a built-in numerical equation solver. That's why one of its keys is labeled SOLVE.

by William M. Kahan

**B**UILT INTO HEWLETT-PACKARD'S new handheld calculator, the HP-34C, is an automatic numerical equation solver. It is invoked by pressing the **SOLVE** key (see Fig. 1). For an illustration of how it finds a root  $x$  of an equation  $f(x) = 0$  take the function

$$f(x) \equiv e^x - C_1x - C_2$$

with constants  $C_1$  and  $C_2$ . Equations  $f(x) = 0$  involving functions like this one have to be solved in connection with certain transistor circuits, black-body radiation, and stability margins of delay-differential equations. If the equation  $f(x) = 0$  has a real root  $x$  three steps will find it:

- Step 1. Program  $f(x)$  into the calculator under, say, label **A** (see Fig. 2).
- Step 2. Enter one or two guesses at the desired root: (first guess) **ENTER** (second guess if any) Any  $x$  will do as a guess provided  $f(x)$  is defined at that value of  $x$ , but the closer a guess falls to a desired root the sooner that root will be found.
- Step 3. Press **SOLVE A** and wait a little while to see what turns up.

Figs. 3a-3d show what turns up for a typical assortment of constants  $C_1$  and  $C_2$  and first guesses.

When a root is found it is displayed. But is it correct? When no root exists, or when **SOLVE** can't find one, **ERROR 6** is displayed. But how does the calculator know when to abandon its search? Why does it not search forever? And if it fails to find a root, what should be done next? These questions and some others are addressed in the sections that follow.

## What does SOLVE Do, and When Does It Work?

Neither **SOLVE** nor any other numerical equation solver can understand the program that defines  $f(x)$ . Instead, equation solvers blindly execute that program repeatedly. Successive arguments  $x$  supplied to the  $f(x)$  program by **SOLVE** are successive guesses at the desired root, starting with the user's guess(es). If all goes well, successive guesses will get closer to the desired root until, ideally,  $f(x)=0$  at the last guess  $x$ , which must then be the root. **SOLVE** is distinguished from other equation solvers by its guessing strategy, a relatively simple procedure that will surely find a root, provided one exists, in an astonishingly wide range of circumstances. The three simplest circumstances are the ones that predominate in practice:

1.  $f(x)$  is strictly monotonic, regardless of initial guesses, or

2.  $\pm f(x)$  is strictly convex, regardless of initial guesses, or
3. Initial guesses  $x$  and  $y$  straddle an odd number of roots, i.e.,  $f(x)$  and  $f(y)$  have opposite signs, regardless of the shape of the graph of  $f$ .



In these cases **SOLVE** always finds a root of  $f(x)=0$  if a root exists.

About as often as not, **SOLVE** must be declared to have found a root even though  $f(x)$  never vanishes. For example, take the function:

$$g(x) \equiv x+2 \cdot (x-5)$$



Fig. 1. The HP-34C, a new handheld programmable calculator, has two keys that are new to handheld calculators— $\int$  (integrate) and **SOLVE SOLVE**, a numerical equation solver, is described in this article.

PRGM  RUN	Switch to Program Mode
CL PRGM	Clear Program Memory
LBL A	x Is in the X Register
e <sup>x</sup>	e <sup>x</sup>
LST x	Get x Back
RCL 1	C <sub>1</sub>
x	C <sub>1</sub> x
-	e <sup>x</sup> - C <sub>1</sub> x
RCL 2	C <sub>2</sub>
-	f(x) = e <sup>x</sup> - C <sub>1</sub> x - C <sub>2</sub>
RTN	Return f(x) in the X register
PRGM  RUN	Switch to Run Mode
... C <sub>1</sub> ...	
STO 1	Store C <sub>1</sub> in Register 1
... C <sub>2</sub> ...	
STO 2	Store C <sub>2</sub> in Register 2

**Fig. 2.** This is an HP-34C program for the function  $f(x) = e^x - C_1x - C_2$ . It replaces  $x$  by  $f(x)$  in the HP-34C's X register (display). It is labeled A, but labels B, 0, 1, 2, or 3 would serve as well.

Of course  $g(x) = 3x - 10$ , and when calculated as prescribed above (don't omit the parentheses!) it is calculated exactly (without roundoff) throughout  $1 \leq x \leq 6.666666666$ . Consequently, the calculated value of  $g(x)$  cannot vanish because the obvious candidate  $x = 10/3 = 3.333\dots$  cannot be supplied as an argument on an ordinary calculator. **SOLVE** does the sensible thing when asked to solve  $g(x) = 0$ ; it delivers final guesses 3.33333333 and 3.33333334 in the X and Y registers in a few seconds. In general, when **SOLVE** finds a root of  $f(x) = 0$  it returns two final guesses  $x$  and  $y$  in the X and Y registers respectively; either  $x = y$  and  $f(x) = 0$ , or else  $x$  and  $y$  differ in their last (10th) significant decimal digit and  $f(x)$  and  $f(y)$  have opposite signs. In both cases the Z register will contain  $f(x)$ .

On the other hand, **SOLVE** may fail to find a place where  $f(x)$  vanishes or changes sign, possibly because no such place exists. Rather than search forever, the calculator will stop where  $|f(x)|$  appears to be stationary, near either a local positive minimum of  $|f(x)|$  as illustrated in Fig. 3d or where  $f(x)$  appears to be constant. Then the calculator displays ERROR 6 while holding a value  $x$  in the X register and  $f(x)$  in the Z register for which  $f(y)/f(x) \geq 1$  at every other guess  $y$  that was tried, usually at least four guesses on each side of  $x$ . (One of those guesses is in the Y register.) When this happens the calculator user can explore the behavior of  $f(x)$  in the neighborhood of  $x$ , possibly by pressing **SOLVE** again, to see whether  $|f|$  really is minimal near  $x$ , as it is in Fig. 3d, or whether the calculator has been misled by unlucky guesses. More about this later.

So **SOLVE** is not foolproof. Neither is any other equation solver, as explained on page 23.

### How Does SOLVE Compare with Other Root-Finders?

Program libraries for large and small computers and cal-

culators usually contain root-finding programs, but none of them works over so wide a range of problems or so conveniently as does the HP-34C's **SOLVE** key. Other root-finders are hampered by at least some of the following limitations:

1. They insist upon two initial guesses that straddle an odd number of roots. **SOLVE** accepts any guess or two and does what it can to find a root nearby, if possible, or else farther away.
2. They may have to be told in advance how long they are permitted to search lest they search forever. Consequently their search permit may expire after a long search, but just moments before they would have found a root. **SOLVE** knows when to quit; it can't go on forever, but it can go on for a long time (e.g., when  $f(x) = 1/x$ ).
3. They may require that you prescribe a tolerance and then oblige you to accept as a root any estimate closer than that tolerance to some previous estimate, even if both estimates are silly. **SOLVE** will claim to have found a root  $x$  only when either  $f(x) = 0$  or  $f(x) \cdot f(y) < 0$  for some  $y$  differing from  $x$  only in their last (10th) significant decimal digit.
4. They may claim that no root exists when they should admit that no root was found. **SOLVE** will not abandon its search unless it stumbles into a local minimum of  $|f|$ , namely an argument  $x$  for which  $f(y)/f(x) \geq 1$  at all other (usually at least nine) sampled arguments  $y$  on both sides of  $x$ .

5. They may deny to the program that calculates  $f(x)$  certain of the calculator's resources; for instance

"begin with no label other than A"

"do not use storage registers 0 through 8"

"do not use certain operations like CLR or ="

**SOLVE** allows the  $f(x)$  program to use everything in the calculator except the **SOLVE** key. Moreover, **SOLVE** may be invoked from another program just like any other key on the calculator; and  $f(x)$  can use the HP-34C's powerful  $\int_y^x$  key.

A lot of thought has gone into making **SOLVE** conform to Albert Einstein's dictum: "As simple as possible, but no simpler."

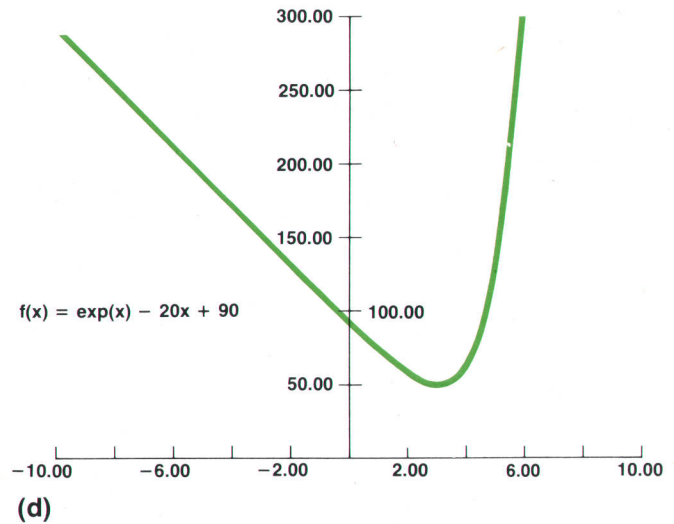
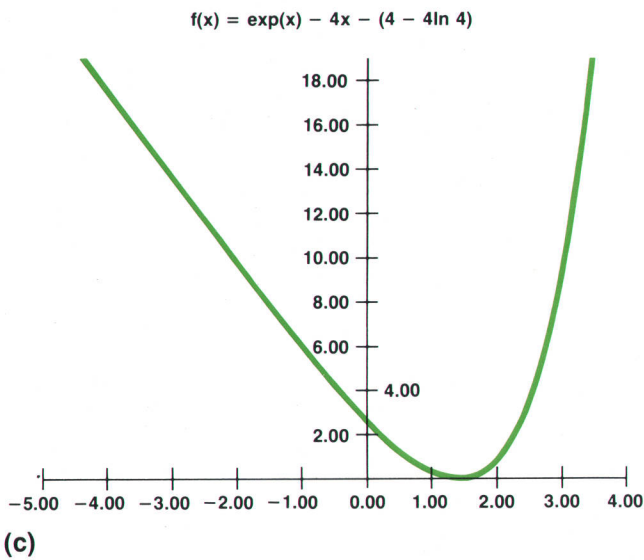
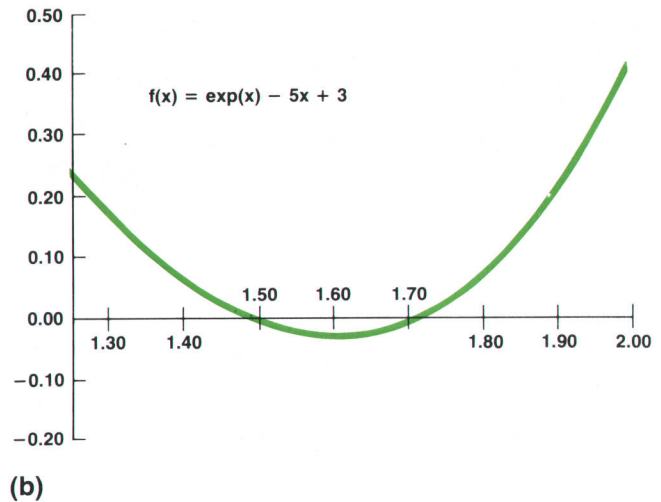
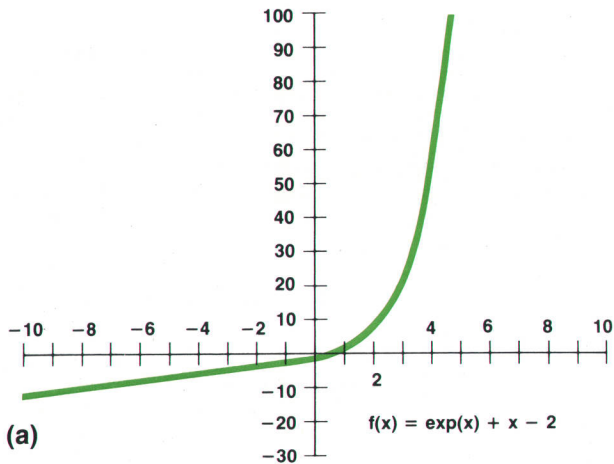
### How Does SOLVE Work?

The **SOLVE** key's microprogram uses very little of the HP-34C's resources. Reserved for **SOLVE**'s exclusive use are just five memory registers for data and a handful of other bits. Those five memory registers hold three sample arguments  $\alpha$ ,  $\beta$ , and  $\gamma$  and two previously calculated sample values  $f(\alpha)$  and  $f(\beta)$  while the user's  $f(x)$  program is calculating  $f(x)$  from the argument  $x = \gamma$ , which it found in the stack. How does **SOLVE** choose that argument  $\gamma$ ?

Suppose  $\alpha$  and  $\beta$  both lie close to a root  $x = \zeta$  of the equation  $f(x) = 0$ . Then a secant (straight line) that cuts the graph of  $f$  at the points  $[x = \alpha, y = f(\alpha)]$  and  $[x = \beta, y = f(\beta)]$  must cut the  $x$ -axis at a point  $[x = \gamma, y = 0]$  given by

$$\gamma = \beta - (\beta - \alpha) \cdot f(\beta) / (f(\beta) - f(\alpha)) \quad (1)$$

Provided the graph of  $f$  is smooth and provided  $\zeta$  is a simple root, i.e.,  $f(\zeta) = 0 \neq f'(\zeta)$ , then as Fig. 4 suggests,  $\gamma$  must approximate  $\zeta$  much more closely than do  $\alpha$  and  $\beta$ . In fact the new error  $\gamma - \zeta$  can be expressed as



**Fig. 3.** Examples of **SOLVE** results for different values of  $C_1$  and  $C_2$  and different first guesses for the root  $x$  in the program of Fig. 2. (a) If the first guess is  $-99$  the root  $x = 0.442854401$  is found in 25 seconds. The graph of  $f(x)$  on the negative- $x$  side is relatively straight, so **SOLVE** works quickly. If the first guess is 99 the root is found in 190 seconds. **SOLVE** takes longer to get around a sharp bend. (b) With first guesses 0 and 2 the root 1.468829255 is found in 30 seconds. With first guesses 2 and 4 the root  $x = 1.74375199$  is found in 20 seconds. Many root finders have trouble finding nearby roots. (c) With first guesses 0 and 2 the double root 1.386277368 is found in 50 seconds. Many root finders cannot find a double root at all. (d) Since no root exists, **SOLVE** displays **ERROR 6**. With first guesses of 0 and 10, **SOLVE** displays **ERROR 6** in 25 seconds. After the error is cleared **SOLVE** displays 2.32677..., which approximates the place  $x = 2.99573...$  where  $f(x)$  takes its minimum value 50.085....

$$\gamma - \zeta = K \cdot (\alpha - \zeta) \cdot (\beta - \zeta)$$

where  $K$  is complicated but very nearly constant when  $\alpha$  and  $\beta$  both lie close enough to  $\zeta$ . Consequently the secant formula, equation 1, improves good approximations to  $\zeta$  dramatically, and it may be iterated (repeated): after  $f(\gamma)$  has been calculated  $\alpha$  and  $f(\alpha)$  may be discarded and a new and better guess  $\delta$  calculated from a formula just like equation 1:

$$\delta = \gamma - (\gamma - \beta) \cdot f(\gamma) / (f(\gamma) - f(\beta)) \quad (2)$$

This process repeated constitutes the secant iteration and is the foundation underlying the operation of

the **SOLVE** key.

A lot could be said about the secant iteration's ultimately rapid convergence, but for two reasons the theory hardly ever matters. First, the theory shows how strongly the secant formula (equation 1) improves good estimates of a root without explaining how to find them, even though the search for these estimates generally consumes far more time than their improvement. Second, after good estimates have been found, the secant iteration usually improves them so quickly that, after half a dozen iterations or so, the tiny calculated values of  $f(x)$  fall into the realm of rounding error noise. Subsequent applications of equation 1 are confounded by relatively inaccurate values  $f(\alpha)$  and  $f(\beta)$  that

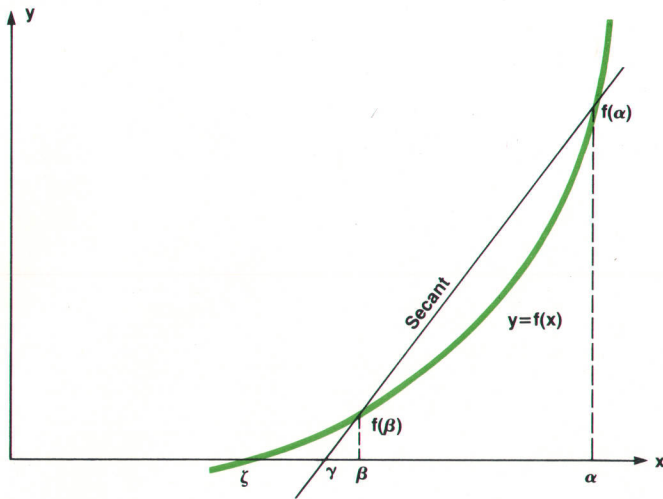


Fig. 4. Given guesses  $\alpha$  and  $\beta$  with corresponding function values  $f(\alpha)$  and  $f(\beta)$  the secant iteration produces a new guess  $\gamma$  by the formula  $\gamma = \beta - (\beta - \alpha) \cdot f(\beta) / (f(\beta) - f(\alpha))$ .

produce a spurious value for the quotient  $f(\beta) / (f(\beta) - f(\alpha))$ . For these reasons the secant iteration is capable of dithering interminably (or until the calculator's battery runs down). Figs. 5a-5b show examples where the secant iteration cycles endlessly through estimates  $\alpha, \beta, \gamma, \delta, \alpha, \beta, \gamma, \delta, \dots$

Therefore, the secant iteration must be amended before it can serve the SOLVE key satisfactorily.

SOLVE cannot dither as shown in Fig. 5a because, having discovered two samples of  $f(x)$  with opposite signs, it constrains each successive new guess to lie strictly between every two previous guesses at which  $f(x)$  took opposite signs, thereby forcing successive guesses to converge to a place where  $f$  vanishes or reverses sign. That constraint is accomplished by modifying equation 2 slightly to bend the

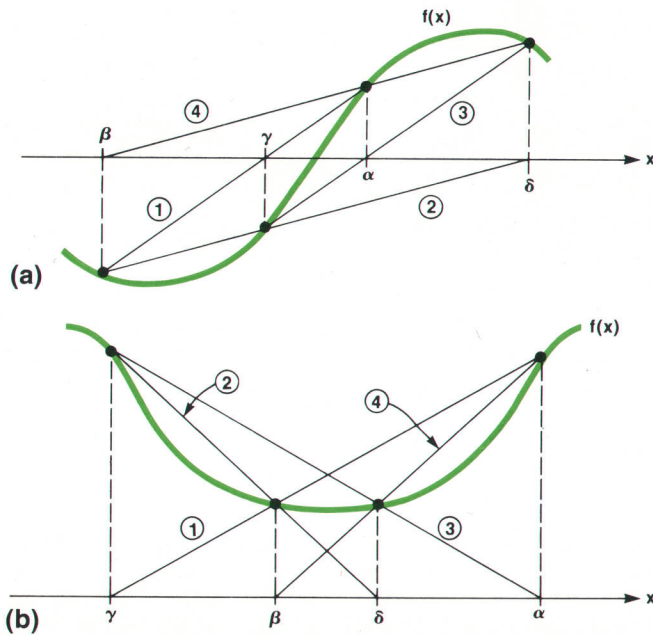


Fig. 5. Examples of how the secant iteration can cycle endlessly through the values  $\alpha, \beta, \gamma, \delta$ . (1)  $\alpha, \beta \rightarrow \gamma$  (2)  $\beta, \gamma \rightarrow \delta$  (3)  $\gamma, \delta \rightarrow \alpha$  (4)  $\delta, \alpha \rightarrow \beta$  and so forth.

## Why Is Equation Solving Provably Impossible?

"The merely Difficult, we do immediately; the Impossible will take slightly longer." Old British naval maxim.

What makes equation solving merely difficult is the proper calculation of  $f(x)$  when the equation  $f(x) = 0$  has to be solved. Sometimes the calculated values of  $f(x)$  can simultaneously be correct and yet utterly misleading. For example, let  $g(x) = x + 2 \cdot (x - 5)$ ; this is the function whose calculated values change sign but never vanish. Next let the constant  $c$  be the calculated value of  $(g(10/3))^2$ ; this amounts to  $c = 10^{-18}$  on an HP handheld calculator, but another calculator may get some other positive value. Finally, let  $f(x) = 1 - 2 \exp(-g^2(x)/c^2)$ . The graph of  $f$  crosses the  $x$ -axis despite the fact that the correctly rounded value calculated for  $f(x)$  is always 1. None of the arguments  $x$  for which  $f(x)$  differs significantly from 1 can be keyed into the calculator, so it has no way to discover that  $f(x)$  vanishes twice very near  $10/3$ , namely at

$$x = 10/3 \pm c \sqrt{\ln 2/3}$$

No numerical equation solver could discover those roots.

Worse, perhaps, than roots that can't be found are roots that aren't roots. Here is an example where the calculator cannot know whether it has solved  $f(x) = 0$  or  $f(x) = \infty$ . Consider the two functions

$$f(x) = 1/g(x) \text{ and } f(x) = 1/(g(x) + c^2/g(x))$$

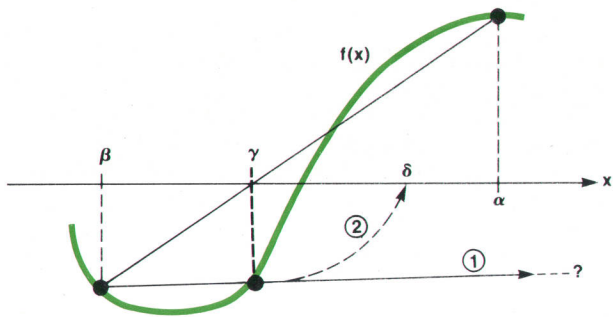
where  $g(x)$  and  $c$  are defined above. These two functions have identical calculated values, after rounding, for every  $x$  that can be keyed into the calculator, which consequently can't tell one from the other despite the fact that at  $x = 10/3$  the first has a pole,  $f(10/3) = \infty$ , and the second a zero,  $f(10/3) = 0$ . Starting from straddling initial guesses  $x = 1$  and  $x = 10$  the SOLVE key finds a "root" of both equations  $f(x) = 0$  to lie between  $3.333333333$  and  $3.333333334$  after only 49 samples. The user, not the calculator, must decide whether the place where  $f(x)$  changes sign is a root of  $f(x) = 0$  or not. A similar decision arises when both initial guesses lie on the same side of  $10/3$ , in which case SOLVE ultimately finds a "root" of  $f(x)$  at some huge  $x$  with  $|x| > 3.33 \times 10^{98}$ , where the calculated value of  $f(x)$  underflows to zero. That huge  $x$  must be regarded as an approximation to  $x = \pm \infty$  where both functions  $f(\pm \infty) = 0$ .

The foregoing examples illustrate how our inability to perform calculations with infinitely many figures makes equation solving difficult. What makes equation solving impossible, even if rounding errors never happened, is our natural desire to decide after only finitely many samples of  $f(x)$  whether it never vanishes. Any procedure that claims to accomplish this task in all cases can be exposed as a fraud as follows:

First apply the procedure to "solve"  $f(x) = 0$  when  $f(x) = -1$  everywhere, and record the finitely many sample arguments  $x_1, x_2, x_3, \dots, x_n$  at which  $f(x)$  was calculated to reach the decision that  $f(x)$  never vanishes. Then apply the procedure again to  $f(x) = (x - x_1) \cdot (x - x_2) \cdot (x - x_3) \cdot \dots \cdot (x - x_n) - 1$ . Since both functions  $f(x)$  take exactly the same value,  $-1$ , at every sample argument, the procedure must decide the same way for both: both equations  $f(x) = 0$  have no real root. But that is visibly not so.

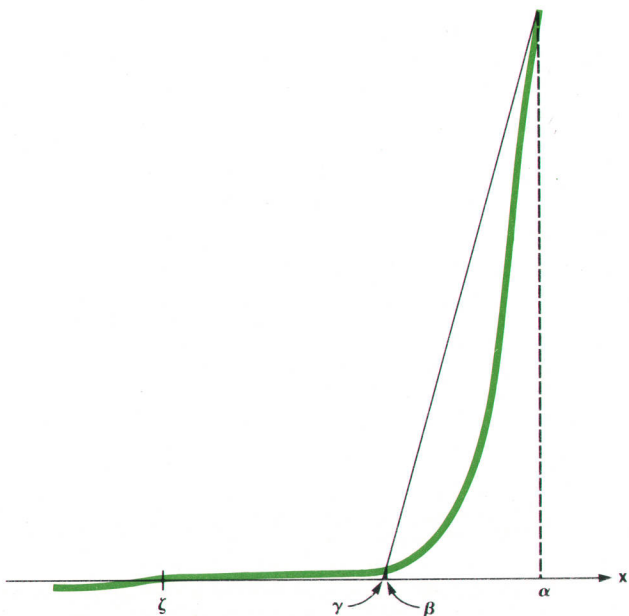
So equation solving is impossible in general, however necessary it may be in particular cases of practical interest. Therefore, ask not whether SOLVE can fail; rather ask, "When will it succeed?"

Answer: Usually.

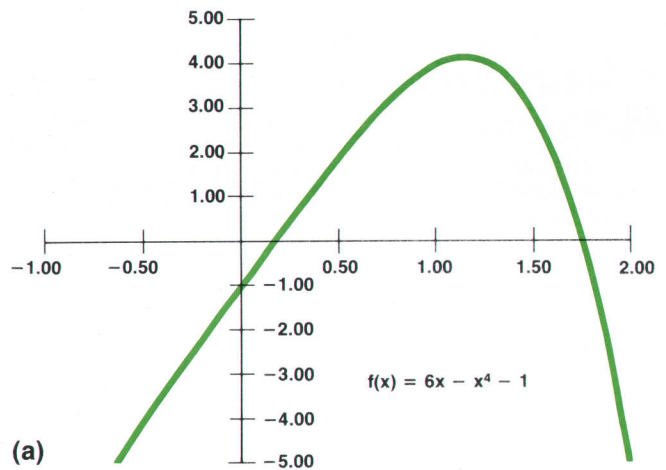


**Fig. 6.** In the HP-34C, once two samples of  $f(x)$  with opposite signs have been discovered, the secant line (1) is bent to (2) whenever necessary to prevent an iterate  $\delta$  from escaping out of the shortest interval known to contain a place where  $f(x)$  reverses sign.

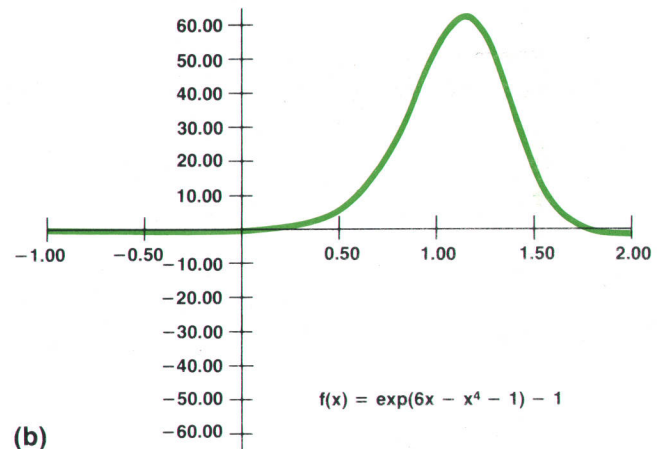
secant occasionally as illustrated in Fig. 6. Another small modification to compensate for roundoff in the secant formula (equation 1) protects it from the premature termination illustrated in Fig. 7. Although **SOLVE** can now guarantee convergence ultimately, that might not be soon enough since ultimately we all lose patience. Fortunately, convergence cannot be arbitrarily slow. At most six and normally fewer iterations suffice to diminish either successive errors  $|x - \zeta|$  or successive values  $|f(x)|$  by an order of magnitude, and rarely are more than a dozen or two iterations needed to achieve full ten-significant-digit accuracy. So fierce is the bent-secant iteration's urge to converge that it will converge to a pole (where  $f(x) = \infty$ ) if no zero (where  $f(x) = 0$ ) is available, and this is just as well because poles and zeros cannot be distinguished by numerical means



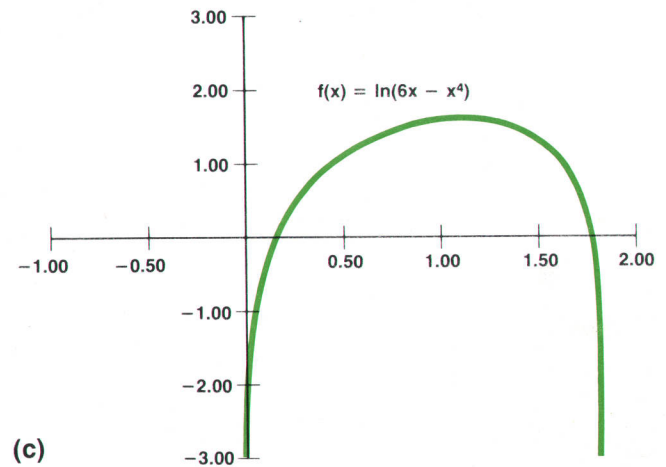
**Fig. 7.** With a wild initial guess  $\alpha$  the rounded value of  $\gamma$  may coincide with  $\beta$ . This convinces some equation solvers that  $\gamma$  is the root. **SOLVE** perseveres until it locates the root  $\zeta$  correctly.



(a)



(b)



(c)

**Fig. 8.** These three equations all have the same roots, but (a) is easy to solve, (b) with a bad initial guess gets worse, and equation (c) is defined only close to its roots.

alone (see page 23).

What does **SOLVE** do when all the values  $f(x)$  sampled so far have the same sign? As long as successive samples  $f(x)$  continue to decline in magnitude, **SOLVE** follows the secant formula (equation 1) with two slight amendments. One amendment prevents premature termination (see Fig. 7). The other deals with nearly horizontal secants, when  $f(\alpha) = f(\beta)$  very nearly, by bending them to force  $|\gamma - \beta| \leq$



$100|\beta-\alpha|$ , thereby diminishing the secant iteration's tendency to run amok when roundoff becomes significant. Convergence now cannot be arbitrarily slow. As long as successive samples  $f(x)$  continue to decline in magnitude without changing sign they must decline to a limit at least as fast, ultimately, as a geometric progression with common ratio  $1/2$ , and usually much faster. When samples  $f(x)$  decline to zero, **SOLVE** finds a root. When they decline to a nonzero limit, as must happen when  $f(x) = 1 + e^x$  or otherwise declines asymptotically to a nonzero limit as  $x \rightarrow \pm\infty$ , **SOLVE** discovers that limit and stops with either **ERROR 6**, meaning no root was found, or  $\pm 9.999999999 \times 10^{99}$ , meaning overflow, in the display.

A different approach is needed when a new sample  $f(\gamma)$  exhibits neither a different sign nor a diminished magnitude. To avoid the dithering exhibited in Fig. 5b, **SOLVE** sets the secant formula (equation 2) aside. Instead, it interpolates a quadratic through the three points  $[\alpha, f(\alpha)]$ ,  $[\beta, f(\beta)]$ ,  $[\gamma, f(\gamma)]$  and sets  $\delta$  to the place where that quadratic's derivative vanishes. In effect,  $\delta$  marks the highest or lowest point on a parabola that passes through the three points. **SOLVE** then uses  $\delta$  and  $\beta$  as two guesses from which to resume the secant iteration. At all times  $\beta$  and  $f(\beta)$  serve as a record of the smallest  $|f(x)|$  encountered so far.

But the parabola provides no panacea. Roughly, what it does provide is that if  $|f(x)|$  has a relatively shallow minimum in the neighborhood of  $\beta$  and  $\delta$ , the calculator will usually look elsewhere for the desired root. If  $|f(x)|$  has a relatively deep minimum the calculator will usually remember it until either a root is found or **SOLVE** abandons the search.

The search will be abandoned only when  $|f(\beta)|$  has not decreased despite three consecutive parabolic fits, or when accidentally  $\delta = \beta$ . Then the calculator will display **ERROR 6** with  $\beta$  in the X register,  $f(\beta)$  in the Z register, and  $\gamma$  or  $\delta$  in the Y register. Thus, instead of the desired root, **SOLVE** supplies information that helps its user decide what to do next. This decision might be to resume the search where it left off, to redirect the search elsewhere, to declare that  $f(x)$  is negligible so  $x$  is a root, to transform  $f(x)=0$  into another equation easier to solve, or to conclude that  $f(x)$  never vanishes.

When invoked from a running program **SOLVE** does something more useful than stop with **ERROR 6** in the display: it skips the next instruction in the program. The cal-

culator's user is presumed to have provided some program to cope with **SOLVE**'s possible failure to find a root, and then **SOLVE** skips into that program. This program might calculate new initial guesses and reinvoke **SOLVE**, or it might conclude that no real root exists and act accordingly. Therefore, **SOLVE** behaves in programs like a conditional branch: if **SOLVE** finds a root it executes the next instruction, which is most likely a **GTO** instruction that jumps over the program steps provided to cope with failure. Therefore the HP-34C, alone among handheld calculators, can embed equation-solving in programs that remain entirely automatic regardless of whether the equations in question have solutions.

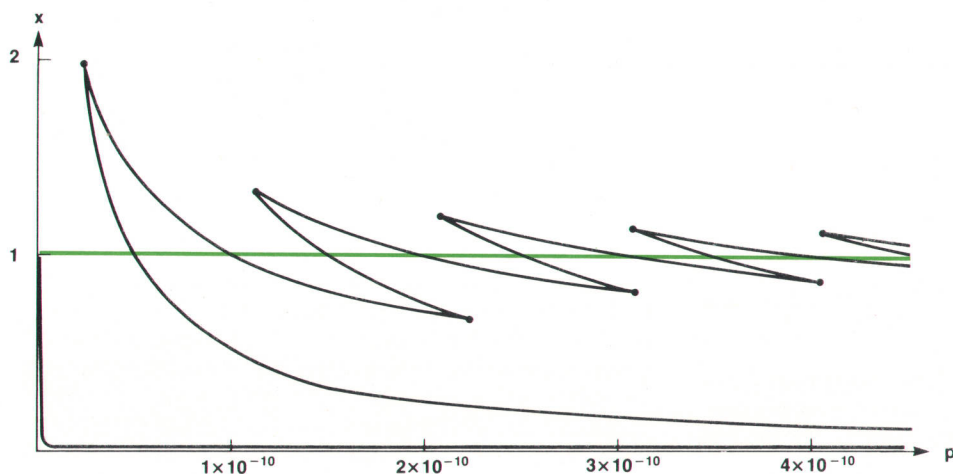
### Some Problem Areas

Equation solving is a task beset by stubborn pathologies; in its full generality the task is provably impossible (see page 23). Even though equations that matter in practice may not fall into the Chasm of the Impossible, yet they may teeter on the brink. Rather than leave the user teetering too, the HP-34C Owner's Handbook devotes two chapters to **SOLVE**, one introductory and one more advanced. The second chapter discusses equation solving in general rather than the **SOLVE** key alone, and supplies the kind of helpful advice rarely found in textbooks. Here follow examples of things that users might need to know but are unlikely to have learned except from bitter experiences, which the Handbook tries to forestall.

**Hard versus Easy Equations.** The two equations  $f(x)=0$  and  $\exp(f(x))-1=0$  have the same real roots, yet one is almost always much easier to solve numerically than the other. For instance, when  $f(x) \equiv 6x-x^4-1$  the first equation is easier. When  $f(x) \equiv \ln(6x-x^4)$  the second is easier. See Figs. 8a-8c.

In general, every equation is one of an infinite family of equivalent equations with the same real roots, and some of those equations must be easier to solve than others. If your numerical method fails to solve one of those equations, it may succeed with another.

**Inaccurate Equations.** Numerical equation solvers have been known to calculate an equation's root wrongly. That cannot happen to **SOLVE** unless the equation is wrongly calculated, which is what happens in the next example. This example resembles equations that have to be solved during financial calculations involving interest rates or yields on investments. For every  $p \geq 0$  the equation



**Fig. 9.** The jagged solid line is a graph of the ostensible roots of  $x - (1 - \exp(-xp)) / xp = 0$  calculated carrying ten significant digits. The colored line is a plot of the correct root  $x = 1$  (to nine significant digits) obtained by a rearranged calculation.

$$x - h(px) = 0,$$

where  $h(0) = 1$  and  $h(z) \equiv (1 - \exp(-z))/z$  if  $z \neq 0$ , has just one root  $x$ , and  $0 < x \leq 1$ . The colored line in Fig. 9 plots this root  $x$  against  $p$ , and shows how smoothly  $x \rightarrow 1$  as  $p \rightarrow 0$ . But when that root  $x$  is calculated numerically for tiny values of  $p$  using the most straightforward program possible, something awful happens, as shown by the black graph in Fig. 9. That serrated graph reflects the capricious way in which the calculated equation's left-hand side changes sign—once for  $p = 10^{-11}$  at “root”  $x = 10^{-88}$ , seven times for  $p = 2.15 \times 10^{-10}$  at “roots”  $x = 4.65 \times 10^{-90}$ , 0.233, 0.682, 0.698, 0.964, 1.163 and 1.181. All those “roots” are wrong; the correct root is  $x = 0.999999999\dots$ . These aberrations are caused by one rounding error, the one committed when  $\exp(-px)$  is rounded to 10 significant digits. Carrying more figures will not dispel the aberrations but merely move them elsewhere.

To solve  $x - h(px) = 0$  correctly one must calculate  $h(z)$  accurately when  $z$  is tiny. Here is the easiest way to do that: if  $\exp(-z)$  rounds to 1 then set  $h(z) = 1$ , otherwise set  $h(z) = (\exp(-z) - 1)/\ln \exp(-z)$ . This reformulation succeeds on all recent HP handheld calculators because the **LN** key on these calculators retains its relative accuracy without degradation for arguments close to 1 (see reference 1). Consequently,  $\ln \exp(-z)$  conserves the rounding error in the last digit of  $\exp(-z)$  well enough for that error to cancel itself in the subsequent division, thereby producing an accurate  $h(z)$  and a trustworthy root  $x$ .

Generally, wrong roots are attributable more often to wrong equations than to malfunctioning equation solvers. The foregoing example, in which roundoff so contaminated the first formula chosen for  $f(x)$  that the desired root was obliterated, is not an isolated example. Since the **SOLVE** key cannot infer intended values of  $f(x)$  from incorrectly calculated values, it deserves no blame for roots that are wrong because of roundoff. Getting roots right takes carefully designed programs on carefully designed calculators.

**Equations with Several Roots.** The more numerous the roots the greater is the risk that some will escape detection. Worse, any roots that cluster closely will usually defy attempts at accurate resolution. For instance, the double root in Fig. 3c ought to be  $x = \ln 4 = 1.386294361$  instead of 1.386277368, but roundoff in the 10th decimal causes the calculated  $f(x)$  to vanish throughout  $1.386272233 \leq x \leq 1.386316488$ , thereby obscuring the last half of the double root's digits. Triple roots tend to lose 2/3 of the digits carried, quadruple roots 3/4, and so on. All these troubles can be attacked by finding where the first few derivatives  $f'(x)$ ,  $f''(x)$ , etc. vanish, but nobody knows how to guarantee victory in all cases.

### What Have We Learned?

The reader will recognize, first, how little the pathologies illustrated above have to do with the specifics of the **SOLVE** key, and second, how nearly certain is the user of so powerful a key to stumble into pathologies sooner or later, however rarely. While the **SOLVE** key enhances its user's powers it obliges its user to use it prudently or be misled.

And here is Hewlett-Packard's dilemma. The company cannot afford a massive effort to educate the public in nu-

merical analysis. But without some such effort most potential purchasers will remain unaware of **SOLVE**'s value to them. And without more such effort many actual purchasers may blame their calculator for troubles that are intrinsic in the problems they are trying to **SOLVE**. To nearly minimize that required effort and its attendant risks, **SOLVE** has been designed to be more robust, more reliable and much easier to use than other equation solvers previously accepted widely by the computing industry. Whether that effort is enough remains to be seen. Meanwhile we enjoy the time **SOLVE** saves us when it works to our satisfaction, which is almost always.

### Acknowledgments

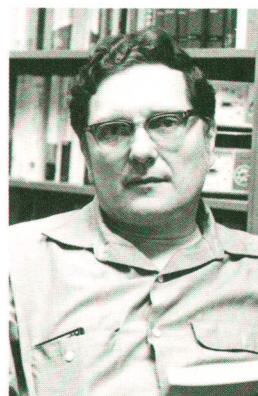
I am grateful for help received from Dennis Harms, Stan Mintz, Tony Ridolfo and Hank Schroeder. Hank wrote the Handbook's chapters on **SOLVE**. Tony found ways to improve the **SOLVE** key's program while microcoding it. Dennis contributed some improvements too, both to the program and to this explanation of it, but I owe him most thanks for, along with Stan, supporting our efforts enthusiastically despite justifiable doubts.

### Reference

1. D.W. Harms, "The New Accuracy: Making  $2^3=8$ ," Hewlett-Packard Journal, November 1976.

---

### William M. Kahan



William Kahan is professor of mathematics and computer science at the University of California at Berkeley. An HP consultant since 1974, he has helped develop increasingly accurate arithmetic and elementary functions for the HP-27, 67/97, 32E, and 34C Calculators, financial functions for the HP-92 and 38E/C, and other functions for the HP-32E and 34C, including  $\int$  and **SOLVE** for the 34C. A native of Toronto, Canada, he received his BA and PhD degrees in mathematics and computer science from the University of Toronto in 1954 and 1958, then taught those subjects at Toronto for ten years before moving to Berkeley. A member of the American Mathematical Society, the Association for Computing Machinery, and the Society for Industrial and Applied Mathematics, he has authored several papers and served as a consultant to several companies. He is married, has two teenage sons, and lives in Berkeley.

---

## Viewpoints

### Don Loughry on ANSI/IEEE Standard 488 and the HP Interface Bus

Frequent reference has been made in these pages to the HP Interface Bus (HP-IB) as Hewlett-Packard's implementation of IEEE Standard 488, "Digital Interface for Programmable Instrumentation." Since inception of IEEE 488 in 1975, Hewlett-Packard has striven to make HP's implementation a proper implementation of IEEE 488. In each case this represents a valid subset as not every device needs to use all the 488 capabilities. However, the HP-IB is more—significantly more—than just the appropriate set of IEEE 488 options.

The IEEE (and now ANSI) 488 Standard, referred to elsewhere as the GPIB, defines the mechanical, electrical, and functional aspects of an interface in terms that are independent of devices or systems. To start with, HP products that have the HP-IB capability use the complete mechanical and electrical specifications of ANSI/IEEE 488 plus appropriate functional capabilities selected from the standard (e.g. basic talker, listener, serial poll and service request capabilities, parallel poll and device trigger capabilities, etc.) A complete product interface, however, embraces additional operational characteristics at both the machine interface and human operator levels. Consequently, most HP products incorporate user-oriented features that may be related to but are beyond the normal content of an interface standard. For example, in recognition of the need to facilitate user interaction with a device, most HP instruments have front-panel layouts and nomenclature that provide rapid identification of how those instruments are programmed over the HP-IB. The nomenclature for a spectrum analyzer's front-panel controls to select center frequency, for instance, highlights the C and the F to indicate that CF is the mnemonic for programming that control.

In the same vein, systems that make use of the HP-IB interface concepts are provided with software to facilitate user interaction with the system. For example, typical HP-IB systems that use a computer are supplied with general-purpose drivers that take care of addressing, sending commands, effecting end of record, and responding to service requests with minimal, if any, operator interaction. The user need be concerned, therefore, only with application data. In addition, the documentation contains verification routines and program examples; a typical application program is frequently provided to introduce the new user to the system and its capabilities.

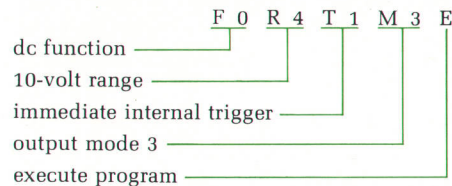
These added capabilities, both hardware and software related, are all part of the HP-IB concept that goes beyond the 488 standard. Thus, HP-IB may be thought of as ANSI/IEEE 488 plus added user features that facilitate user understanding, convenience, and efficiency in interacting with HP-IB products. (Further details on these added features will be discussed in a forthcoming Journal article. Ed.)

#### Codes and Formats

For some time, HP has made use of generalized formats for device-oriented messages such as those needed for sending program data to a device and returning measurement results back to the controller. The overall structure of these messages is specified in a device- and system-independent manner. Each device then uses the generalized format by supplying or interpreting device-specific data bytes.

In general, the format for program data strings consists of sets of

alphanumeric character sequences. One or more alpha characters identify a parameter and the numeric field identifies the parameter selection or value. Specific code assignments, however, are unique to each device. For example, the following message programs a voltmeter to measure a dc voltage on the 10-volt range upon receipt of an internal trigger, and then output the measured quantity.



The voltmeter's response to the command might be:

OLDC + 12002E - 03CRLF

Here, the OLDC provides summary status data indicating that the measurement is a dc voltage but the value, in this case +12.002 volts expressed in exponential notation, is beyond the normal 10-volt range specified and is therefore flagged as an overload condition. This message can be divided into three fields: header (alpha only), numeric value representing the measured quantity, and separator or ending to the message (the carriage return/line feed). The overall structure of the format is defined but individual product implementations select the particular message elements appropriate for that product.

Standardization efforts are now in progress at national and international levels to provide a set of guidelines for the preferred syntax and formats applicable to products with ANSI/IEEE 488 capability. It is anticipated that balloting will be initiated on an IEEE Recommended Practice within a few months.

#### Revisions to the Standard

Revisions to the ANSI/IEEE 488 standard itself were completed and published in November 1978. Since its inception as a published document in April 1975, the 488 Standard has been read and interpreted by many engineers (14,000 copies distributed prior to the 1978 revision) and as a result, a number of comments were received concerning the clarity of certain clauses. For example, in one clause it was possible to misinterpret just when the END message could be sent. In addition, a few clauses needed to be reworded to reflect the onward march of technology (e.g., the wide use of Schottky drivers mandates the use of +0.5V<sub>OL</sub>, the low-state output voltage).

Thus, a revision of the standard was called for and completed in 1978. The predominant changes and additions are clarifications—editorial changes that have no impact on technical matters (see the IEEE Standard 488-1978 Foreword for a complete revision list). However, in several instances technically related issues were addressed with due consideration for backward compatibility.

During the revision period, one additional problem area was discovered. Under certain "take control synchronously" (TCS) conditions it was possible for an idle device to misinterpret a data byte (DAB) as an improper message. This condition is a minor

oversight in the standard itself. The proper correction is an additional CSHS (controller standby hold state) state for the C Function to delay assertion of the ATN (attention) message, thereby precluding momentary coexistence of DAV (data valid) and ATN as viewed by an idle device. This correction, which pertains only to devices containing the controller function, has been approved by the IEEE Standards Board and is expected to be issued shortly as Supplement A to the standard.

While the ANSI/IEEE 488 interface standard is enjoying considerable success, international standardization activity has progressed also. IEC (International Electrotechnical Commission) Publication 625-1, entitled "An Interface System for Programmable Measuring Apparatus," is expected by year end. It is the equivalent of ANSI/IEEE 488 in all but one respect: the connector. International interest in a 25-pin connector has been high and is specified in IEC 625-1 rather than the 24-pin connector of ANSI/IEEE 488. Unfortunately, the 25-pin connector is used extensively as part of EIA Standard RS-232C for data communications, which may employ voltage levels of  $\pm 25V$ —not very compatible with TTL circuits. Thus, establishment of two widely used interface standards with the same connector but incompatible signal levels seemed an inappropriate way for ANSI/IEEE standardization in the United States, particularly in view of the increased interest in both data communications and remote instrumentation.

Publication of the IEC 625-1 Standard should further benefit manufacturers and users alike. Today, products manufactured by more than 185 companies in at least 14 different countries use the capabilities of these standards (it is possible to interconnect devices using the 24-pin connectors with those using the 25-pin connector, via a simple adapter cable, one per system).

### Progress in Components

The ANSI/IEEE 488 interface complements the widespread use of microprocessors in terms of such factors as data path width and ability to handle asynchronous data transfers. Further, within the last year several semiconductor firms introduced LSI chips to facilitate the implementation of IEEE 488 designs. These chips, which contain all but the controller function, should enable expeditious incorporation of the interface in additional products in a cost- and performance-effective manner.

HP has used some of these chips to implement the HP-IB in

several designs and some internally designed LSI chips in others.

### Today and the Future

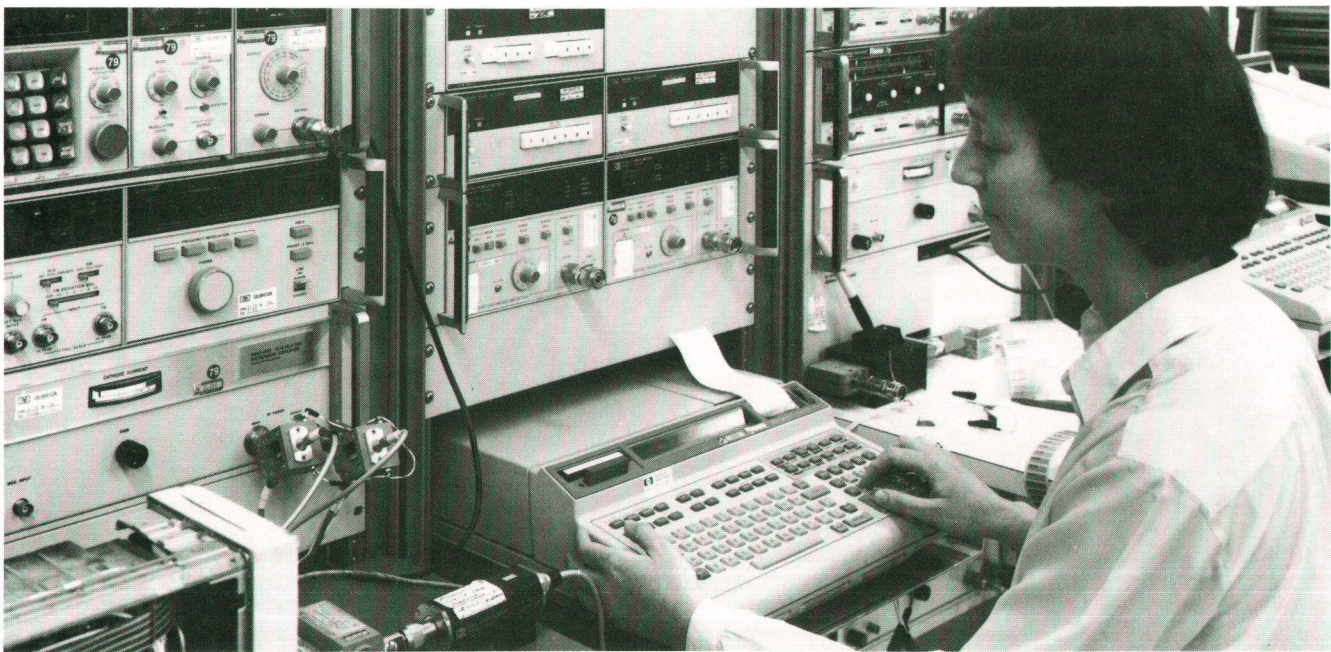
When IEEE Standard 488 was first published, HP was already offering 30 products with HP-IB capability. Today, that number has grown to 150 HP products spanning the spectrum from electronic measurement and stimulus instruments to medical and analytical equipment, from small desktop controllers to full-scale minicomputer controllers, from simple cable assemblies to complete instrumentation and computing systems.

Worldwide, the number of products introduced with IEEE 488 capability is doubling every two years or so. There are now about 750 products with IEEE 488 capability or equivalent (i.e., HP-IB, IEEE Bus, IEC 625, GPIB, Plus Bus, etc.). The interface is used most frequently as the primary (or only) interface port for bench instruments (measurement and stimulus devices), which account for about 56% of the bus-compatible products. Controllers account for another 11%, storage and display for 8%, and complete systems of all types for about 12%. The balance covers a wide spectrum: cable assemblies, quad transceivers, LSI chips, and couplers to convert BCD interfaces to IEEE 488, and to convert IEEE-488 bus signals to a serialized version to extend the maximum bus distance beyond 20 metres (see the article on page 3 of this issue and also D. Guest, "An HP-IB Extender for Distributed Instrument Systems," *Hewlett-Packard Journal*, August 1979). There are even products that use IEEE-488 concepts for such devices as environmental test chambers and automatic screw-driver equipment.

It is impossible to predict exactly what the future holds but the current use of these interface concepts both within HP and on a national and international level testifies that the IEEE 488 and its IEC and HP-IB counterparts serve a highly useful purpose today and certainly for the foreseeable future.



*Don Loughry, Computer Systems Group engineer, was involved with the initial definition and specification of the HP-IB at its inception in 1971. Since then, he has continued to support the standardization process throughout HP and within the framework of IEEE, ANSI, and related IEC standards projects. With a BSEE degree from Union College, Don has held a number of engineering positions since joining HP in 1956. When not working on digital interface concepts, Don can be found interfacing with his bonsai garden.*



# Four-Color Plotters Enhanced for Unattended Operation

*A new automatic paper advance contributes to user convenience by advancing, cutting, and stacking plots in selectable sizes.*

by Majid Azmoon, Randy A. Coverstone, and Richard M. Kemplin

**F**OUR-COLOR GRAPHIC OUTPUT is an element of many applications involving computer or controller-based systems. Three HP programmable plotters provide this capability for different types of systems. Model 9872 is compatible with systems based on the HP Interface Bus, or HP-IB,\* and is programmed in a simple graphics language called HP-GL. Model 7221 is compatible with systems based on the RS-232C (CCITT V.24) interface, and is programmed in a binary language. Model 7220 is also compatible with RS-232C (CCITT V.24) systems, but is programmed in HP-GL. These plotters produce high-quality multicolor plots on any paper size up to 285 × 432 mm (11 × 17 in) or ISO A3.

A new integrated paper advance now makes it possible for these plotters to produce plot after plot without an operator to change paper. This new mechanism provides program control of unattended advance operations. It is a standard feature of Models 9872S, 7221S, and 7220S, and

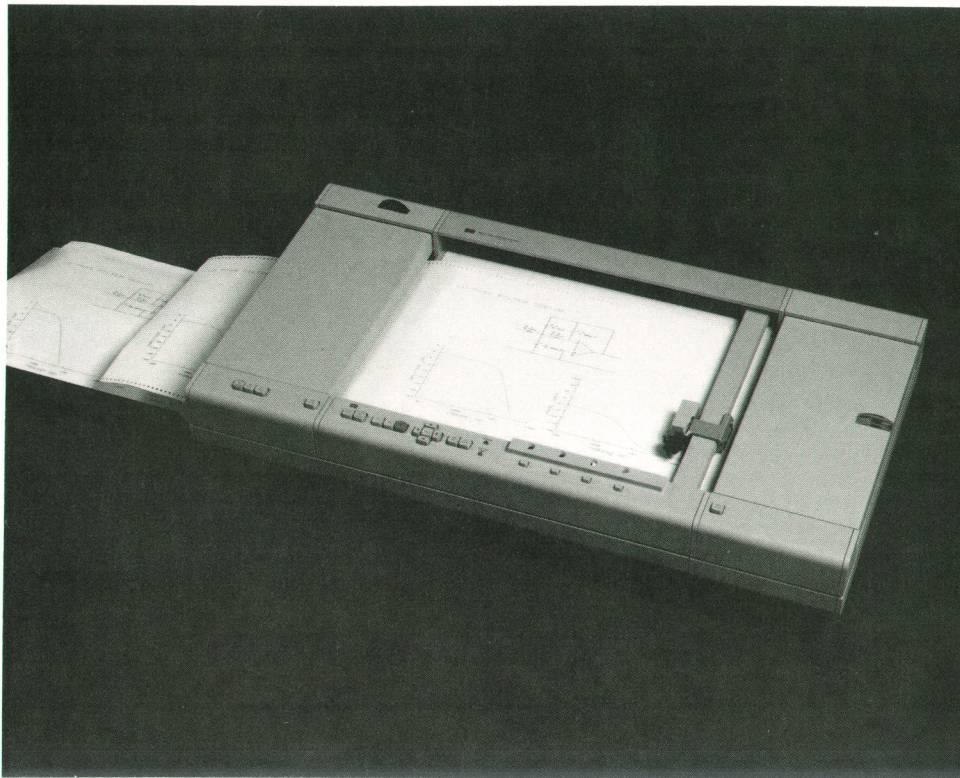
\*Compatible with ANSI/IEEE-488-1978.

can be factory-installed in some (but not all) earlier models of these plotters.

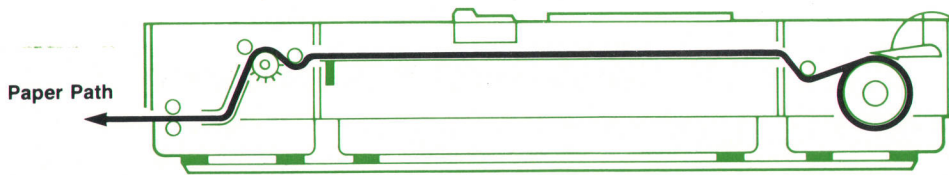
Automatic paper advance is useful for repetitive or sequential graphics output from automated production and engineering test systems, and for unattended graphics operations at a central computer site. A third application area is providing multiple copies of presentation-quality graphs for management reports and presentations. The four-color plotters provide high aesthetic appeal as well as clarity in these graphs. However, if an original graph is photocopied, much of the original impact is lost. The paper advance allows multiple original copies to be made easily, preserving the impact for more information users.

## Design Features

Fig. 1 shows a 9872S Plotter with paper advance. The paper advance is designed to accommodate a 200-foot roll of paper in the right-hand module, or supply side. The paper is fed across the platen and through the left module,



**Fig. 1.** Models 9872S (shown), 7221S, and 7220S are four-color vector plotters that offer a new automatic paper advance system. They can produce plot after plot without an operator to change paper.



**Fig. 2.** Paper drive system holds the paper flat against the platen by applying constant tension to the paper web.

which drives and cuts the paper and feeds the finished sheets into the paper tray.

A continuous-roll paper supply instead of z-fold provides the user a choice of plotting area and final sheet size with no risk of finding a fold or perforations within the plot area. The built-in shear blades and microprocessor can produce mixed page sizes with a single setup, and either single-sheet or continuous output, all under front-panel or program control.

### Paper Drive System

The paper drive system is the most essential and critical part of the paper advance. This system must accurately position the paper on the writing platen, control paper flatness in the plotting area to prevent extraneous marks during pen-up moves, and maintain the paper position to prevent shifting while the plot is being produced. The difficulty of these tasks is increased by the range of environmental conditions imposed upon the system. Reliable operation must be guaranteed over a broad range of temperatures and humidity (to which paper is particularly sensitive), as well as during vibration such as that created by the plotter during operation.

Of these performance requirements, the most difficult is maintaining paper flatness across the platen area. In single-sheet operation, the paper is held in place by the electrostatic table of the plotter. The sheets are placed and flattened by the operator. This method is unsuitable in automatic unattended operation for several reasons. First, even after the electrostatic table is turned off, a large force is required to shear the paper from the table. Thus extremely high tractive forces or a mechanism to peel the paper from the table would be required. Second, without an operator, a mechanism would be required to smooth out the wrinkles as the electrostatic table pulls down the paper. Third, at high humidity the effectiveness of the electrostatic table is diminished. Although an operator can monitor this behavior and tape a single sheet to the platen if required, this obviously presents reliability problems in unattended operation if the electrostatic table is expected to hold the paper. Replacing the electrostatic table with a vacuum table would overcome these problems at the expense of increased cost, complexity, and noise.

These problems are circumvented in the paper drive system by tensioning the paper across the writing table (see Fig. 2). With suitable tension maintained uniformly across the web the required paper flatness is obtained over the desired range of environmental conditions. The electrostatic hold-down is automatically disabled whenever roll paper is tensioned across the table.

The required tension is provided by a pair of brakes in the supply module. The primary brake is mounted to the paper hub, which is keyed to the supply roll. This brake is supplemented by another brake, acting on the circumference of the paper roll, which conveniently doubles as a

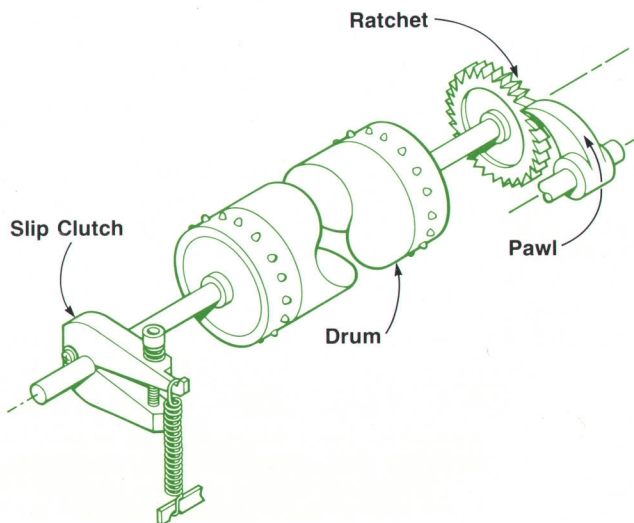
paper supply indicator. The combined braking effect produces a tension that is virtually constant over the diameter range of the supply roll.

The paper is driven by sprockets in the drive module. The paper is perforated at the final sheet width, and sprocket holes are punched outside the perforations. The sprocket drive provides positive registration for accurate advance lengths and lateral guidance. This scheme is also compatible with both English and metric sheet sizes—paper is supplied with appropriate perforation spacing for both sizes.

### Simple Electronics

The electronics complement of the paper advance modules is minimal. Full advantage has been taken of the power and intelligence of the host plotter. Thus the electrical components of the paper advance consist solely of a motor identical to the resident motors of the host plotter, a small printed circuit board containing a relay for the motor driving circuitry and the paper advance front-panel switches, and paper sensor switches.

The modules take advantage of the power supply, microprocessor, input/output capability, and motor drive circuitry of the plotter by simply switching power from the plotter Y-axis to the paper drive motor. At completion of the paper advance, the relay returns power to the plotter Y-axis motor. The plotter reinitializes its position and is restored to the exact configuration that existed immediately before the advance command. The only changes required of the plotter to implement this are the addition of firmware code to accommodate the paper advance sequence, and the cabling to and from the modules.



**Fig. 3.** Page length is held constant and cumulative error eliminated by a combination of a ratchet and a spring-loaded slip clutch.

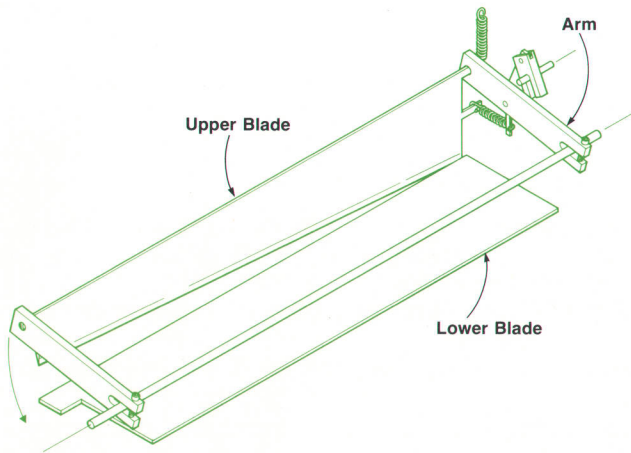


Fig. 4. Paper shear mechanism works like scissors.

### Controlling Advance Accuracy

An important aspect of the paper advance is the control of cumulative error. If preprinted forms are to be used the advance length must not accumulate error if the grid/form registration is to be maintained over a complete roll of paper. This can be accomplished by having the preprinted forms registered accurately to the sprocket holes when they are printed, and by accurately controlling the rotation of the sprocket drive shaft.

To minimize the advance error a ratchet is used in combination with a spring loaded slip clutch (Fig. 3). When the drum reaches the end of its advance, which is a predetermined number of revolutions, it stops and is rotated in the opposite direction by the spring that pulls on the slip clutch. This opposite rotation is limited when the pawl contacts the first available tooth of the ratchet. This mechanism acts as a mechanical analog-to-digital converter to filter out advance length variations caused by gear backlash and motor switching inaccuracies. The result is no variance in page length other than the tolerances built into the ratchet and paper, and no cumulative error whatsoever.

### Paper Shear

As the paper leaves the left side of the machine, it passes between two stainless steel blades. The lower blade is stationary, while the upper blade is driven down by a four-bar linkage driven by the transmission (see Fig. 4).

The blades operate exactly as do ordinary scissors. The upper blade is at an angle to the lower blade both in the vertical plane (shear angle) and in the horizontal plane (interference angle). The upper blade is pivoted and held against the lower blade with a spring. This geometry insures a long life for the cutter. Only point contact is allowed

between the blades, and there is no rubbing action to dull the blades. Repeated and lengthy life tests have failed to damage or wear out the blades, which are self-sharpening.

### Transmission Design

The cutting action and the advance action use the same prime mover, a step motor. The motor drives only a gear train directly, with all other operations controlled by passive clutches. The gear train provides power takeoff points with correct torque capacity for each function of the transmission.

The paper is advanced by forward rotation of the motor with torque transmitted through a dog coupling (see Fig. 5). This coupling is essentially a high-backlash coupling. When paper is to be cut, the motor reverses direction. The paper is held in position by the ratchet as the motor disengages from the sprocket drive shaft. Simultaneously, an overrunning clutch couples the motor to the four-bar linkage to cut the paper. When the upper shear blade completes its stroke, the motor again reverses direction. Initially, although the motor is driving forward, the paper does not advance because the high-backlash dog coupling is not engaged. The shear blade reopens, driven upwards by a spring. The motor still effectively controls the shear opening through the overrunning clutch. When the shear blade is returned to its original full-open position, the overrunning clutch begins slipping again, the dog again engages the sprocket drive, and the paper begins advancing once again.

This simple mechanism allows all three kinematic functions of the transmission (advancing paper, opening the shear blades, and closing them) to be controlled by a single motor, with attendant cost savings.

### Paper Stacking

Once the completed plot has been cut to length, the page passes between rollers located between the blades and the outer wall. Driven continuously by a belt, these rollers give the sheet a final push into the stacking tray. They also isolate the advance system from obstructions or interference occurring outside the machine, thereby preventing jamming of the drive system and consequent loss of data.

### Acknowledgments

The authors would like to acknowledge the contributions made by others to this product. Larry Hennessee worked on the electronics, hardware, and firmware, and Don Hiler did the product design. Thanks also go to Jurgen Przyllas and Tom Young for production and manufacturing engineering support and Rick Mayes for his product marketing contributions.

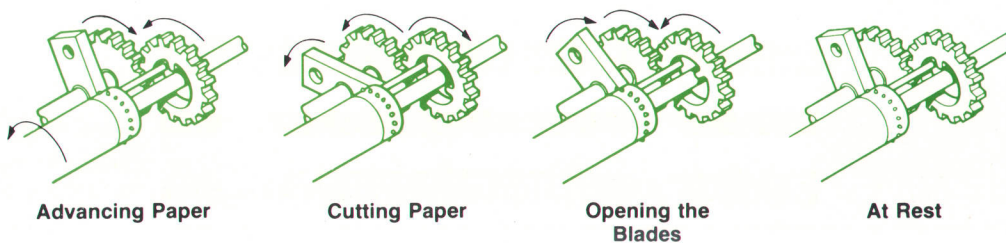


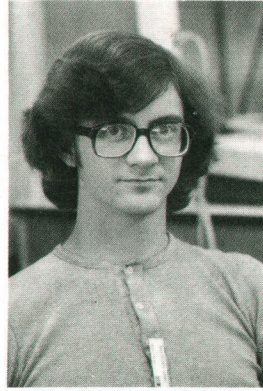
Fig. 5. Dog coupling makes it possible for a single transmission to control all paper advance and paper cutting functions.



**Richard M. Kemplin**

Dick Kemplin has been a draftsman and product designer with HP for 23 years. He helped develop the pen changer, mechanical drive, deck design, and the new automatic paper advance for the 9872, 7220, and 7221 Plotters. He's listed as inventor in five patents on X-Y recorder mechanical design. Dick was born in Glendale, California. He received an AA degree from John Muir College in 1952, then spent two years in the U.S. Army Corps of Engineers before joining HP in 1954. He's married, has four children ranging in age from 9 to 21, lives in Poway,

California, and is half owner of a Comanche 250 aircraft, which he flies whenever he can.



**Randy A. Coverstone**

Randy Coverstone was responsible for transmission design and the paper tensioning and loading schemes on the 9872S/7221S/7220S Plotters. He is currently doing servo design work on a new plotter. In 1975 Randy graduated from the University of Evansville in Indiana with his BSME degree, and in 1978, he received an MSME degree and the degree of Mechanical Engineer from Massachusetts Institute of Technology. He joined HP in 1978. A native of Goshen, Indiana, Randy now lives with his wife in Mira Mesa, an area of San Diego, California. He is currently building an

electronic music synthesizer, and his hobbies include cars, stereo components, and building doll house furniture.



**Majid Azmoon**

Maj Azmoon was project leader for development of the 9872S/7221S/7220S four-color plotter paper advance models. An HP employee since 1973, he previously contributed to the 9872A Plotter and the 7245A Plotter/Printer. He is named as inventor on a patent relating to the 7245A. He earned his BSME degree in 1969 at California Polytechnic University and received his MSME degree two years later at the University of Southern California. Born in Tehran, Iran, Maj now lives in Poway, California, with his wife and two-year-old son. In his spare time he enjoys racquetball,

woodworking, and restoring old Ford Mustangs.

**SPECIFICATIONS**  
**Automatic Paper Advance for**  
**HP Models 9872S, 7221S, and 7220S Graphic Plotters**

- PAGE ADVANCE:** 10-12 seconds typical
- PAGE-TO-PAGE ADVANCE ERROR:** ±0.4 mm (0.016 in) non-cumulative
- PAGE REGISTRATION:** ±2 mm (0.080 in)
- PAGE CUTTING ACCURACY:** at 50% relative humidity +1, -2 mm (0.080 in)
- PRICES IN U.S.A.:** 9872S, \$6500. 7221S, \$6750. 7220S, \$6750.
- MANUFACTURING DIVISION:** SAN DIEGO DIVISION  
16399 West Bernardo Drive  
San Diego, California 92127 U.S.A.

Hewlett-Packard Company, 1501 Page Mill Road, Palo Alto, California 94304

Bulk Rate  
U.S. Postage  
Paid  
Hewlett-Packard  
Company

**HEWLETT-PACKARD JOURNAL**

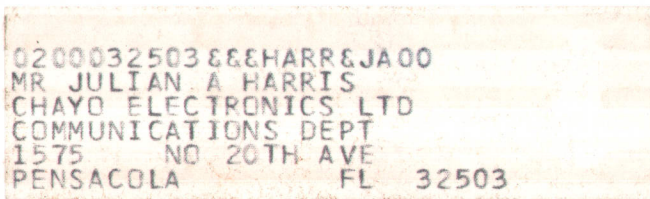
DECEMBER 1979 Volume 30 • Number 12

Technical Information from the Laboratories of  
Hewlett-Packard Company

Hewlett-Packard Company, 1501 Page Mill Road  
Palo Alto, California 94304 U.S.A.

Hewlett-Packard Central Mailing Department  
Van Heuven Goedhartlaan 121  
1180 AM Amstelveen The Netherlands

Yokogawa-Hewlett-Packard Ltd., Suginami-Ku  
Tokyo 168 Japan



**CHANGE OF ADDRESS:** To change your address or delete your name from our mailing list please send us your old address label. Send changes to Hewlett-Packard Journal, 1501 Page Mill Road, Palo Alto, California 94304 U.S.A. Allow 60 days.